

moving limits











PRODUCT OVERVIEW

VACUUM HANDLING TECHNOLOGY

www.aero-lift.de/en

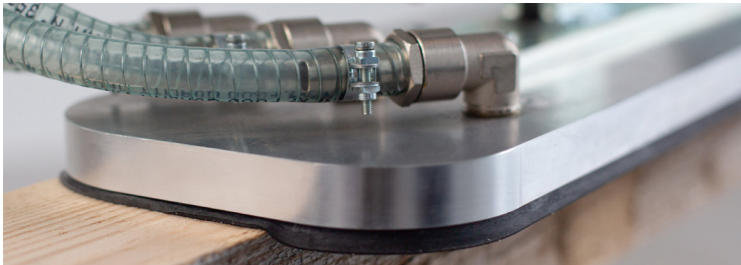
Standard products

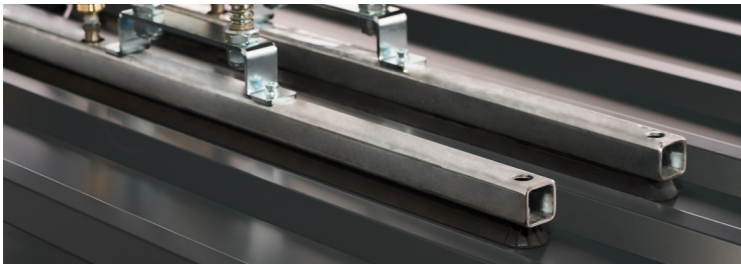
About us	4
Product selection guide	10
Contact	94

	Lifting force	Model	Page
 <p>TUBE LIFTERS</p>	 < 300 kg	FORCE-LIFT FORCE-LIFT 2 FORCE-LIFT 2 ErgoPlus	14 18 24
 <p>LIFTING DEVICES FOR SHEET METAL/PLASTICS</p>	 < 2,000 kg	AERO-BASIC AERO-ADVANCE AERO-INDEPEND AERO-SELECT AERO-90° AERO-180° AERO-CUBE	32 36 40 44 48 52 56
 <p>LIFTING DEVICES FOR WOOD</p>		AERO-PORO AERO-TIMBER	62 66
 <p>LIFTING DEVICES FOR GLASS</p>		AERO-WINDOW AERO-VARIOWIN	72 76
 <p>LIFTING DEVICES FOR CLADDING (OUTDOOR)</p>		CLAD-BOY CLAD-MAN	82 86
 <p>CRANES AND CHAIN HOISTS</p>		STEEL AND ALUMINIUM CRANES, CHAIN HOISTS	92

ABOUT US

Success is an attitude

Progress means always crossing boundaries. This requires courage, openness, skill and passion. Welcome to AERO-LIFT. We invent, develop and distribute handling solutions with vacuum technology. We combine various technologies to create user-orientated system solutions – making the work of people in industry, logistics and trade more efficient and ergonomic, while also saving materials.

With vacuum lifting technology from AERO-LIFT, heavy, unwieldy loads can be moved easily and safely. Our intelligent solutions increase productivity, reduce costs and prevent sickness-related absences. Our aim is to make work easier for people and companies. To this end, we have been developing ever better solutions for years and boldly taking on new challenges. For us, boundaries are there to be overcome. AERO-LIFT – moving limits.



Courage

If we believe that we can get our customers ahead with an innovation, we will pursue it with determination. After all, it is only possible to create ground-breaking solutions if you have the courage to cross boundaries and not only to think "outside the box", but also to take action.

Vision

We live for our customers and state-of-the-art technology. If we can move both of these forward with our innovations, this will also lead to our success and future security.

Partnership

We are customer-focussed and take a solution-oriented approach based on partnerships. Providing a full-service package of advice, planning, implementation and support is a matter of course for us.

Honesty

For all our progress, we are old-fashioned in one respect – for us, our handshake is binding. We mean what we say, and we keep the promises that we make.

Safety

The safety of our systems is always our top priority. Strict quality controls and the continuous development of innovative safety features ensure that we meet this objective.

Reliability

You can rely on that the fact that we will always act as we expect others to – with openness, transparency, honesty and reliability.

Problem solver

We take the greatest pleasure in being presented with an "unsolvable" challenge. As has often been the case, this only spurs us on even more to find a solution.

Regional approach

We come from the land of inventors. As an owner-managed family business, we are rooted in our traditions – even though we now have international operations.



Just three of many good reasons to choose us

Respect and responsibility are instrumental values in determining our actions. Our focus is on our customers and we can offer highly individualised solutions for highly individual problems. We are an owner-managed family business with a healthy mix of "old hands" and young colleagues. We combine experience and innovation, tradition and progress in equal measure.

Our everyday business activity involves being open to market trends and responding to them with sophisticated product innovations. With our systems, our customers have the best tools for any change in the labour market. Our highly ergonomic solutions make work considerably easier and healthier, and production processes more efficient.

1 Portfolio

A comprehensive product portfolio fulfils a wide range of requirements in terms of applications and materials. For even more engineering – aspects of customised special solutions that we have developed over the years are incorporated into our standard products.

2 Perfectionism

We never let up and keep working on a product until it reaches the highest quality standards. Achieving perfection down to the last detail, optimising until the right solution is found, placing maximum demands on materials and workmanship – this only works if, like us, you produce everything yourself.

3 Pioneer

As a technology leader, you have a great responsibility: To stay ahead, you have to keep moving forward. Thanks to our great innovation, we have been a technological pioneer in many applications for a number of years. When it comes to quality and functionality, you can play it safe with us.

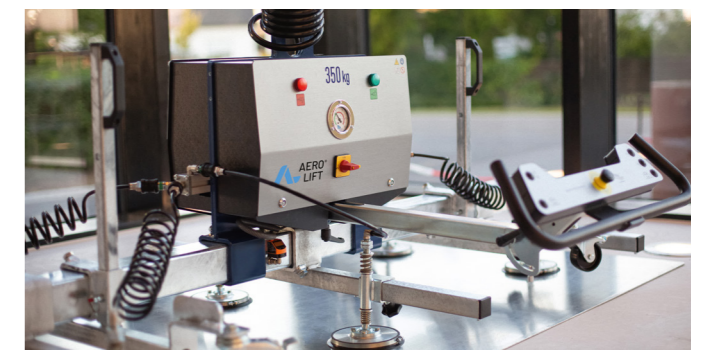
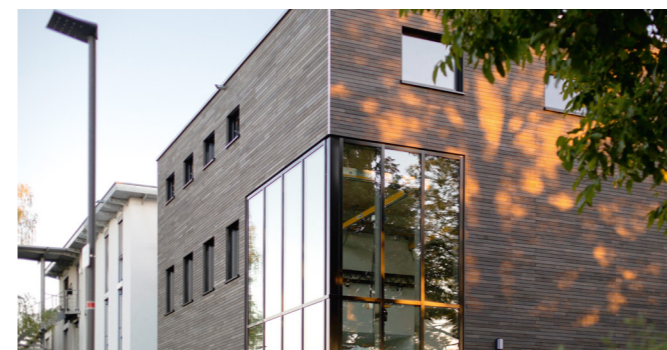



"Thanks to the CLAD-BOY from AERO-LIFT, we can now lay twice the surface area in half the time – easily and safely, without any great effort."

Urs Haller, Markus Haller Zimmerei GmbH & Co. KG

"We now have a faster processing time and an improved material flow. And our employees are very satisfied because less effort is required."

Tobias Ebert, Ebert GmbH & Co. KG, Schreinerei und CNC-Technik

"We received an all-round service package from AERO-LIFT, a real feel-good package."

Volker Walz, Günther+Schramm GmbH

"If I were to take the AERO-LIFT solutions away from my employees again, there would certainly be a small revolution."

Bernd Kayser, Berghof Membrane Technology GmbH

"Thanks to the solution from AERO-LIFT, we can load and unload our laser cutting machine quickly, which, of course, really motivates our employees."

Mario Koch, KTS Technologiepark Stahl

"The number of sick days taken by our employees has decreased since we started using AERO-LIFT solutions. Everyone is more motivated and, ultimately, we are of course more effective."

Kevin Narr, Narr Isoliertechnik GmbH



Ambition and reality



What's the best proof of success? The reactions of customers. Every day, their feedback confirms to us that we are on the right track with our philosophy of courage, quality and innovation.

Together with our customers, we have already created countless solutions, some of which are highly customised and not standard. This has enabled us to help our customers all around the world to achieve greater efficiency, ergonomics and success. And we are rather proud of that.

Product selection guide

Dynamic TUBE LIFTERS with integrated lifting gear

Strong LIFTING DEVICES for heavy loads and large formats

Lifting force	Vacuum lifters	Page	Model	
 < 300 kg	TUBE LIFTERS	14	FORCE-LIFT	
		18	FORCE-LIFT 2	
		24	FORCE-LIFT 2 ErgoPlus	
 < 2,000 kg	LIFTING DEVICES FOR SHEET METAL/ PLASTICS	32	AERO-BASIC	
		36	AERO-ADVANCE	
		40	AERO-INDEPEND	
		44	AERO-SELECT	
		48	AERO-90°	
		52	AERO-180°	
		56	AERO-CUBE	
		LIFTING DEVICES FOR WOOD	62	AERO-PORO
			66	AERO-TIMBER
		LIFTING DEVICES FOR GLASS	72	AERO-WINDOW
76	AERO-VARIOWIN			
LIFTING DEVICES FOR CLADDING (OUTDOOR)	82	CLAD-BOY		
	86	CLAD-MAN		
CRANES & CHAIN HOISTS		92		

Material/lifting goods

Orientation of lifting goods

Cardboard boxes	Barrels	Porous panels	Bags	Canisters	Metal sheets	Plastics	Glass	Panels	Timbers	Sandwich elements	Trapezoidal sheets	Horizontal pick	Vertical pick	Swivelling	Turning	Rotating



TUBE LIFTERS

Material/lifting goods



Cardboard boxes

Barrels

Porous panels

Bags

Canisters

Metal sheets





Plastics

Panels







FORCE-LIFT: ADVANTAGES



- **Lift heavy loads with just one hand:** The FORCE-LIFT is the first one-handed tube lifter that can lift up to 75 kg.
- **Intuitive functionality of the operating handle for quick familiarisation of the user.** The operator can learn how to use the device within a very short time.
- **Maximum flexibility and optimal adaptation to working conditions and lifting goods** thanks to the modular design of the lifting unit and suction pad
- **Absolute all-rounder:** Whether cardboard boxes, bags, canisters or barrels – the integrated quick-change coupling and individually selectable vacuum generators mean that almost anything can be lifted with just one device.
- **Extremely comprehensive equipment of the basic product** including quick-change coupling, motor protection switch (protects the vacuum generator from winding damage), integrated quick-release function (uncoupling function), function for 360° horizontal rotation and 90° tilting function (to grip lifting goods vertically and move them horizontally)
- **Suctioned lifting goods can be parked in different positions** due to the patented valve technology
- **Considerable increase in productivity and efficiency** thanks to its lightness, robustness and high performance

- 
< 75 kg
- 
up to
500 picks/h
- 
Horizontal
pick
- 
Vertical
pick
- 
Rotating

Material/lifting goods

- 
Cardboard
boxes
- 
Barrels
- 
Porous
panels
- 
Bags
- 
Canisters
- 
Plastics





Further details about FORCE-LIFT

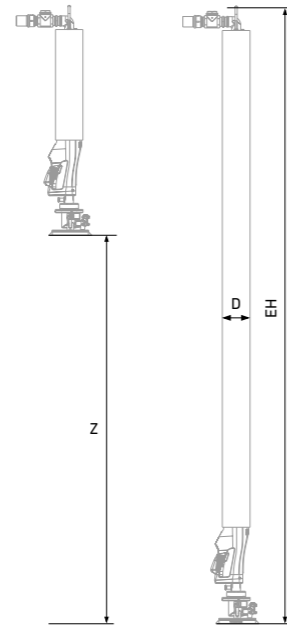

Dimension drawing



Optional configuration / Accessories

Designation	Description
	Sound insulation cover for pump or blower* The sound/ noise level of the vacuum generator is significantly reduced by the sound insulation cover.
	Radio remote control for vacuum generator The vacuum generator can be switched on and off via a radio remote control.
	Wall bracket for vacuum generator The vacuum generator can be mounted on the wall via a steel structure using a wall bracket.
	Magnetic parking position Optional hook and loop strap with magnet for parking the device











*For the 50 m³/h pump, the sound insulation cover is already included in the scope of delivery.

Product data

Horizontal load capacity*	Unladen weight	Lifting tube dia.	Max. stroke	Mounting height	Vacuum generator	Suction volume	Item code
[kg]	[kg]	D	Z	EH		[m ³ /h]	
		[mm]	[mm]	[mm]			
30	6.9	100	1,300	2,270	Vacuum pump	50	FL-30-P50/100/1700
30	6.9	100	1,530	2,570	Vacuum pump	50	FL-30-P50/100/2000
30	6.9	100	1,795	2,870	Vacuum pump	50	FL-30-P50/100/2300
35	9.2	120	1,320	2,270	Vacuum pump	50	FL-35-P50/120/1700
35	9.2	120	1,550	2,570	Vacuum pump	50	FL-35-P50/120/2000
35	9.2	120	1,782	2,870	Vacuum pump	50	FL-35-P50/120/2300
45	9.2	120	1,320	2,270	Vacuum pump	80	FL-45-P80/120/1700
45	9.2	120	1,550	2,570	Vacuum pump	80	FL-45-P80/120/2000
45	9.2	120	1,782	2,870	Vacuum pump	80	FL-45-P80/120/2300
40	9.5	120	1,320	2,270	Vacuum blower	195	FL-40-SV400/120/1700
40	9.5	120	1,550	2,570	Vacuum blower	195	FL-40-SV400/120/2000
40	9.5	120	1,782	2,870	Vacuum blower	195	FL-40-SV400/120/2300
75	13.6	160	1,340	2,270	Vacuum blower	195	FL-75-SV400/160/1700
75	13.6	160	1,580	2,570	Vacuum blower	195	FL-75-SV400/160/2000
75	13.6	160	1,815	2,870	Vacuum blower	195	FL-75-SV400/160/2300

*Depending on the configuration and porosity, the load capacity may be reduced.



Suction feet

Transport goods	No. of suction pl.	Suction pl. dimensions	Unladen weight	Total height	Cross beam length	LT dia. 100 mm	LT dia. 120 mm	LT dia. 160 mm	Type
	[pieces]	[mm]	[kg]	[mm]	[mm]				
	2	85 x 200	2.5	127	400	✓	✓	-	DSF-FL-2L/85x200/NBR-400
	2	110 x 300	3.5	136	400	✓	✓	✓	DSF-FL-2L/110x300/NBR-400
	1	∅ 160	0.8	136	-	✓	-	-	MSF-FL-1F/160/PU
	1	∅ 200	1.1	136	-	✓	✓	-	MSF-FL-1F/200/PU
	1	395 x 210	1.7	120	-	✓	✓	✓	BSF-FL-1M/395x210/LA-KU
	1	∅ 210	1.2	32	-	✓	-	-	MSF-FL-1R/210/NBR
	1	∅ 270	1.3	40	-	✓	✓	-	MSF-FL-1R/270/NBR
	1	∅ 186	1.2	37	-	✓	-	-	MSF-FL-1T/186/EPDM
	1	∅ 226	1.3	37	-	✓	✓	-	MSF-FL-1T/226/EPDM
	-	-	1.4	170	-	✓	✓	✓	HSF-FL









THE FORCE-LIFT | 2: ADVANTAGES



- **Absolute all-rounder:** Whether cardboard boxes, bags, canisters, barrels or even flat goods, such as OSB panels or steel sheets, – the integrated quick-change coupling means that almost anything can be lifted with just one device.
- **Optimal safety for heavy loads of up to 300 kg** as the system can be guided with both hands.
- **Intuitive functionality of the operating handle** for quick familiarisation of the user. The operator can learn how to use the device within a very short time.
- **Maximum flexibility and optimal adaptation to working conditions and lifting goods** thanks to the modular design of the lifting unit and suction pad
- **Robust design:** The housing combines lightness with high robustness and is therefore extremely resistant to external influences.
- **Individually configurable for the respective work situation** due to the different operating handle lengths
- **Extremely comprehensive equipment with the basic product** including quick-change coupling, motor protection switch (protects the vacuum generator from winding damage) and integrated quick-release function (uncoupling function)
- **Suctioned lifting goods can be parked in different positions** because of the innovative valve technology
- **Considerable increase in productivity and efficiency** thanks to its lightness, robustness and high performance

 < 300 kg
  up to 500 picks/h
  Horizontal pick

Material/lifting goods

 Cardboard boxes
  Barrels
  Porous panels
  Bags
  Canisters
  Metal sheets
  Plastics
  Panels

Further details about
FORCE-LIFT | 2



Dimension drawing







Product data

Horizontal load capacity*	Lifting tube dia.	Handle length	Unladen weight	Max. stroke	Mounting height	Vacuum generator	Suction volume	Item code
	D	L G		Z	E H			
[kg]	[mm]	[mm]	[kg]	[mm]	[mm]		[m³/h]	
30	120	250	14.4	1,450	2,431	Vacuum blower	195	FL2-30-25-SV400/120/2000
			14.4	1,790	2,731	Vacuum blower	195	FL2-30-25-SV400/120/2300
			14.4	1,960	3,231	Vacuum blower	195	FL2-30-25-SV400/120/2800
60	160	250	17.3	1,450	2,431	Vacuum blower	195	FL2-60-25-SV400/160/2000
			18.3	1,790	2,731	Vacuum blower	195	FL2-60-25-SV400/160/2300
			18.3	1,960	3,231	Vacuum blower	195	FL2-60-25-SV400/160/2800
		500	19.1	1,450	2,431	Vacuum blower	195	FL2-60-50-SV400/160/2000
			19.1	1,790	2,731	Vacuum blower	195	FL2-60-50-SV400/160/2300
			19.1	1,960	3,231	Vacuum blower	195	FL2-60-50-SV400/160/2800
95	200	750	24	1,450	2,431	Vacuum blower	195	FL2-60-75-SV400/160/2000
			24	1,790	2,731	Vacuum blower	195	FL2-60-75-SV400/160/2300
			24	1,960	3,231	Vacuum blower	195	FL2-60-75-SV400/160/2800
		250	21	1,850	2,831	Vacuum blower	195	FL2-95-25-SV400/200/2400
			21	1,960	3,231	Vacuum blower	195	FL2-95-25-SV400/200/2800
			500	21.8	1,850	2,831	Vacuum blower	195
21.8	1,960	3,231		Vacuum blower	195	FL2-95-50-SV400/200/2800		
750	26.7	1,850		2,831	Vacuum blower	195	FL2-95-75-SV400/200/2400	
	26.6	1,960	3,231	Vacuum blower	195	FL2-95-75-SV400/200/2800		
	1,000	27.5	1,850	2,831	Vacuum blower	195	FL2-95-100-SV400/200/2400	
25.4		1,200	2,831	Vacuum blower	195	FL2-235-25-SV400/300/2400		
235		300	500	26.2	1,200	2,831	Vacuum blower	195
	750		31.1	1,200	2,831	Vacuum blower	195	FL2-235-75-SV400/300/2400
	1,000		31.9	1,200	2,831	Vacuum blower	195	FL2-235-100-SV400/300/2400

*Depending on the configuration and porosity, the load capacity may be reduced. The load capacity is reduced by the weight of the suction foot.









Optional configuration / Accessories

Designation	Description
 Sound insulation cover for vacuum generator	The sound/noise level of the vacuum generator is significantly reduced by the sound insulation cover.
 Radio remote control for blower	The vacuum generator can be switched on and off via a radio remote control.
 Wall bracket for vacuum generator	The vacuum generator can be mounted on the wall via a steel structure using a wall bracket.
 Spring balancer	A spring balancer ensures that the system is kept in balance at all times.



 < 300 kg up to 500 picks/h Horizontal pick









Material/lifting goods







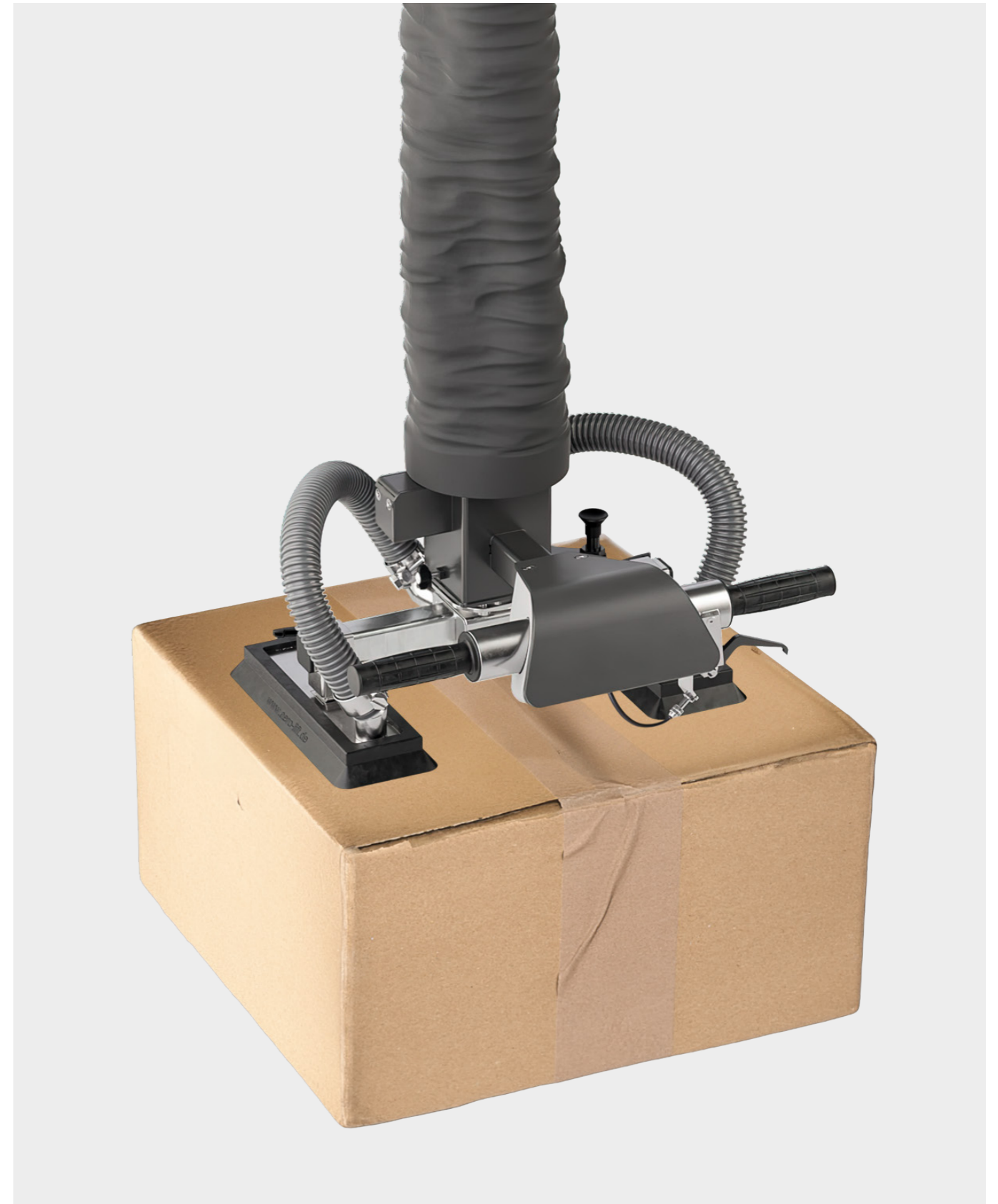

 Cardboard boxes Barrels Porous panels Bags Canisters Metal sheets Plastics Panels

Further details about
FORCE-LIFT | 2



Suction feet



Transport goods	No. of suction pl.	Suction pl. dim.	Unlad. weight	Tot. height	Main cross beam leng.	Cross beam leng.	LT dia. 120 mm	LT dia. 160 mm	LT dia. 200 mm	LT dia. 300 mm	Compat. w. handle length	Type
	[pieces]	[mm]	[kg]	[mm]	[mm]	[mm]					[mm]	
	2	85x200	3.4	103	400	-	✓	-	-	-	all	DSF-FL2-2L/85x200/NBR-400
			4.6	103	400	-	✓	✓	-	-	all	DSF-FL2-2L/110x300/NBR-400
		110x300	5.7	103	800	-	✓	✓	-	-	all	DSF-FL2-2L/110x300/NBR-800
			6.9	103	1,200	-	✓	✓	-	-	all	DSF-FL2-2L/110x300/NBR-1200
			5.7	103	400	-	✓	✓	✓	-	all	DSF-FL2-2L/200x300/NBR-400
		200x300	6.8	103	800	-	✓	✓	✓	-	all	DSF-FL2-2L/200x300/NBR-800
		7.9	103	1,200	-	✓	✓	✓	-	all	DSF-FL2-2L/200x300/NBR-1200	
  	4	85x200	10.5	192	800	400	✓	✓	-	-	250	FSF-4L/85x200/NBR-800/400-250
			11.4	192	800	400	✓	✓	-	-	500	FSF-4L/85x200/NBR-800/400-500
			12.5	192	800	400	✓	✓	-	-	750	FSF-4L/85x200/NBR-800/400-750
			14.4	192	1,200	800	✓	✓	-	-	500	FSF-4L/85x200/NBR-1200/800-500
			15.3	192	1,200	800	✓	✓	-	-	750	FSF-4L/85x200/NBR-1200/800-750
			15.9	192	1,600	800	✓	✓	-	-	500	FSF-4L/85x200/NBR-1200/800-500
			16.8	192	1,600	800	✓	✓	-	-	750	FSF-4L/85x200/NBR-1600/800-750
			12.7	192	800	400	✓	✓	✓	-	250	FSF-4L/110x300/NBR-800/400-250
			13.6	192	800	400	✓	✓	✓	-	500	FSF-4L/110x300/NBR-800/400-500
			14.5	192	800	400	✓	✓	✓	-	750	FSF-4L/110x300/NBR-800/400-750
			16.5	192	1,200	800	✓	✓	✓	-	500	FSF-4L/110x300/NBR-1200/800-500
			17.5	192	1,200	800	✓	✓	✓	-	750	FSF-4L/110x300/NBR-1200/800-750
	200x300		18.0	192	1,600	800	✓	✓	✓	-	500	FSF-4L/110x300/NBR-1600/800-500
			19.1	192	1,600	800	✓	✓	✓	-	750	FSF-4L/110x300/NBR-1600/800-750
			20.0	192	1,600	800	✓	✓	✓	-	1,000	FSF-4L/110x300/NBR-1600/800-1000
			14.8	192	800	400	✓	✓	✓	✓	250	FSF-4L/200x300/NBR-800/400-250
			15.7	192	800	400	✓	✓	✓	✓	500	FSF-4L/200x300/NBR-800/400-500
			16.6	192	800	400	✓	✓	✓	✓	750	FSF-4L/200x300/NBR-800/400-750
			18.6	192	1,200	800	✓	✓	✓	✓	500	FSF-4L/200x300/NBR-1200/800-500
			19.6	192	1,200	800	✓	✓	✓	✓	750	FSF-4L/200x300/NBR-1200/800-750
			20.1	192	1,600	800	✓	✓	✓	✓	500	FSF-4L/200x300/NBR-1600/800-500
			21.1	192	1,600	800	✓	✓	✓	✓	750	FSF-4L/200x300/NBR-1600/800-750
	22.0	192	1,600	800	✓	✓	✓	✓	1,000	FSF-4L/200x300/NBR-1600/800-1000		
	1	395x210	3.4	131	-	-	✓	✓	-	-	all	BSF-FL2-1M/395x210/SW-KU
	1	∅ 210	1.9	58	-	-	✓	-	-	-	all	MSF-FL2-1T/210/EPDM
		∅ 270	2.5	58	-	-	✓	✓	-	-	all	MSF-FL2-1T/270/EPDM
		∅ 350	3.5	58	-	-	✓	✓	✓	-	all	MSF-FL2-1T/350/EPDM
		∅ 450	8.2	58	-	-	✓	✓	✓	✓	all	MSF-FL2-1T/450/EPDM
	-	-	2.1	195	-	-	✓	✓	✓	-	all	HSF-FL2











FORCE-LIFT | 2 ErgoPlus: ADVANTAGES



- **Maximum ergonomics:** The FORCE-LIFT | 2 ErgoPlus achieves maximum ergonomics at both extremely high and low working heights thanks to its special, dynamic angled operating handle.
- **Absolute all-rounder:** Whether cardboard boxes, bags, canisters, barrels or even flat goods, such as OSB panels or steel sheets, – the integrated quick-change coupling means that almost anything can be lifted with just one device.
- **Lift heavy loads with both hands for optimal safety:** The FORCE-LIFT | 2 ErgoPlus enables users to lift loads of up to 75 kg.
- **Intuitive functionality of the operating handle** for quick familiarisation of the user. The operator can learn how to use the device within a very short time.
- **Maximum flexibility and optimal adaptation to working conditions and lifting goods** thanks to the modular design of the lifting unit and suction pad
- **Robust design:** The housing combines lightness with high robustness and is therefore extremely resistant to external influences.
- **Extremely comprehensive equipment with the basic product** including quick-change coupling, motor protection switch (protects the vacuum generator from winding damage) and integrated quick-release function (uncoupling function)
- **Suctioned lifting goods can be parked in different positions** due to the innovative valve technology
- **Considerable increase in productivity and efficiency** thanks to its lightness, robustness and high performance

 < 75 kg
 up to 500 picks/h
 Horizontal pick

Material/lifting goods

 Cardboard boxes
 Barrels
 Porous panels
 Bags
 Canisters
 Metal sheets
 Plastics
 Panels

Further details about FORCE-LIFT 1 2 ErgoPlus



Dimension drawing

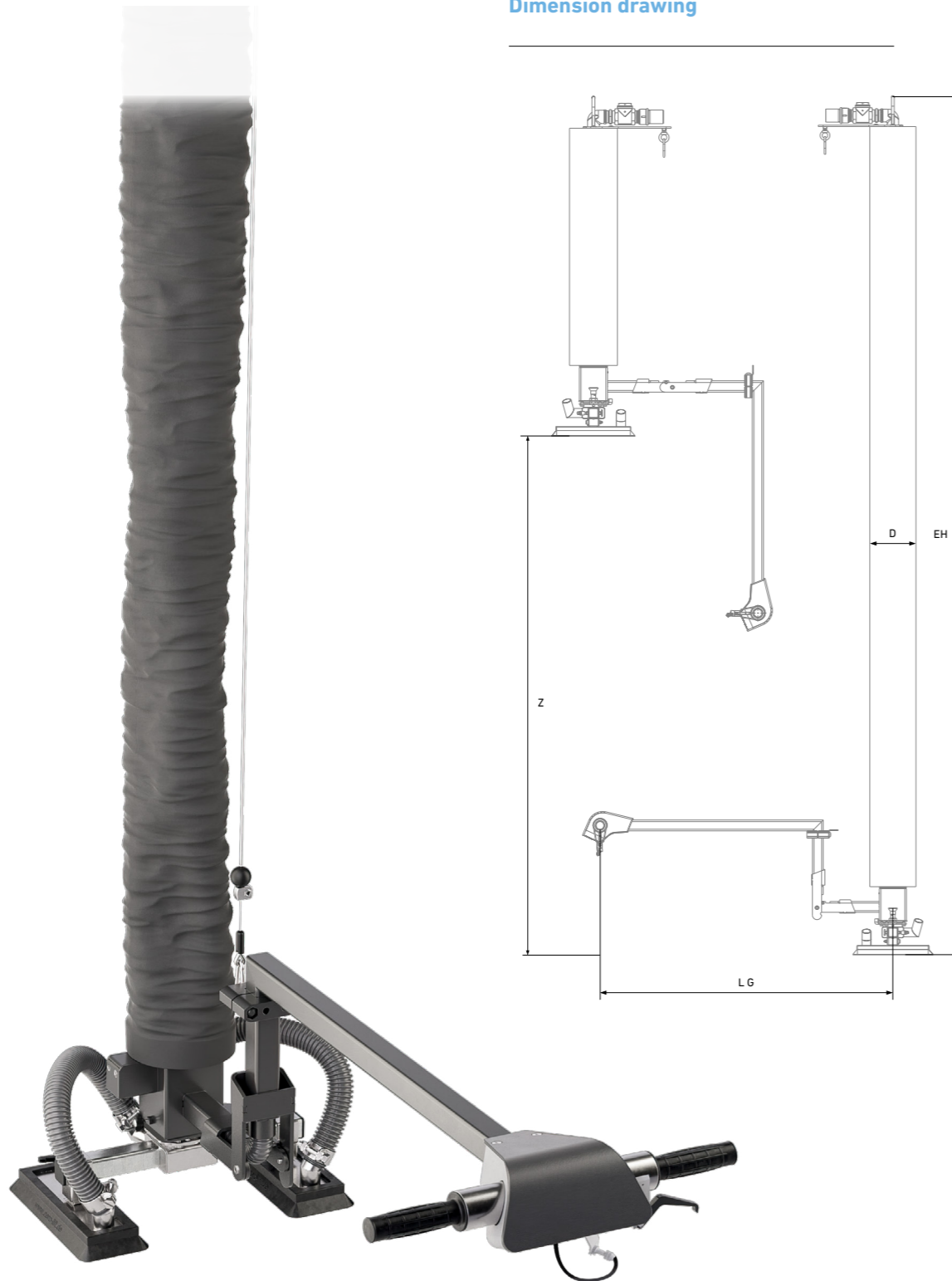



Product data



Horizontal load capacity*	Unladen weight	Lifting tube dia.	Handle length	Max. stroke	Mounting height	Vacuum generator	Suction volume	Item code
[kg]	[kg]	D	L G	Z	E H		[m³/h]	
		[mm]	[mm]	[mm]	[mm]			
30	23	120	500 + 800	1,960	3,231	Vacuum blower	195	FLEP-30-5080-SV400/120/2800
60	27.3	160	500 + 800	1,960	3,231	Vacuum blower	195	FLEP-60-5080-SV400/160/2800

*Depending on the configuration and porosity, the load capacity may be reduced. The load capacity is reduced by the weight of the suction foot.









Optional configuration / Accessories

Designation	Description
 Sound insulation cover for vacuum generator	The sound/noise level of the vacuum generator is significantly reduced by the sound insulation cover.
 Radio remote control for blower	The vacuum generator can be switched on and off via a radio remote control.
 Wall bracket for vacuum generator	The vacuum generator can be mounted on the wall via a steel structure using a wall bracket.

FORCE-LIFT | 2 ErgoPlus

 < 75 kg
 up to 500 picks/h
 Horizontal pick





Material/lifting goods

 Cardboard boxes
 Barrels
 Porous panels
 Bags
 Canisters
 Metal sheets
 Plastics
 Panels

Further details about FORCE-LIFT 1 2 ErgoPlus



Suction feet

Transport goods	No. of suction pl.	Suction pl. dim.	Unlad. weight	Tot. height	Main cross beam leng.	Cross beam leng.	LT dia. 120 mm	LT dia. 160 mm	Compat. w. handle length	Type
	[pieces]	[mm]	[kg]	[mm]	[mm]		✓	✓	[mm]	
	2	85x200	3.4	103	400	-	✓	-	all	DSF-FL2-2L/85x200/NBR-400
		110x300	4.6	103	400	-	✓	✓	all	DSF-FL2-2L/110x300/NBR-400
			5.7	103	800	-	✓	✓	all	DSF-FL2-2L/110x300/NBR-800
		6.9	103	1200	-	✓	✓	all	DSF-FL2-2L/110x300/NBR-1200	
	4	85x200	10.5	192	800	400	✓	✓	250	FSF-4L/85x200/NBR-800/400-250
			11.4	192	800	400	✓	✓	500	FSF-4L/85x200/NBR-800/400-500
			12.5	192	800	400	✓	✓	750	FSF-4L/85x200/NBR-800/400-750
			14.4	192	1200	800	✓	✓	500	FSF-4L/85x200/NBR-1200/800-500
			15.3	192	1200	800	✓	✓	750	FSF-4L/85x200/NBR-1200/800-750
			15.9	192	1600	800	✓	✓	500	FSF-4L/85x200/NBR-1600/800-500
			16.8	192	1600	800	✓	✓	750	FSF-4L/85x200/NBR-1600/800-750
	1	395x210	3.4	131	-	-	✓	✓	all	BSF-FL2-1M/395x210/SW-KU
	1	Ø 210	1.9	58	-	-	✓	-	all	MSF-FL2-1T/210/EPDM
		Ø 270	2.5	58	-	-	✓	✓	all	MSF-FL2-1T/270/EPDM
	-	-	2.1	195	-	-	✓	✓	all	HSF-FL2



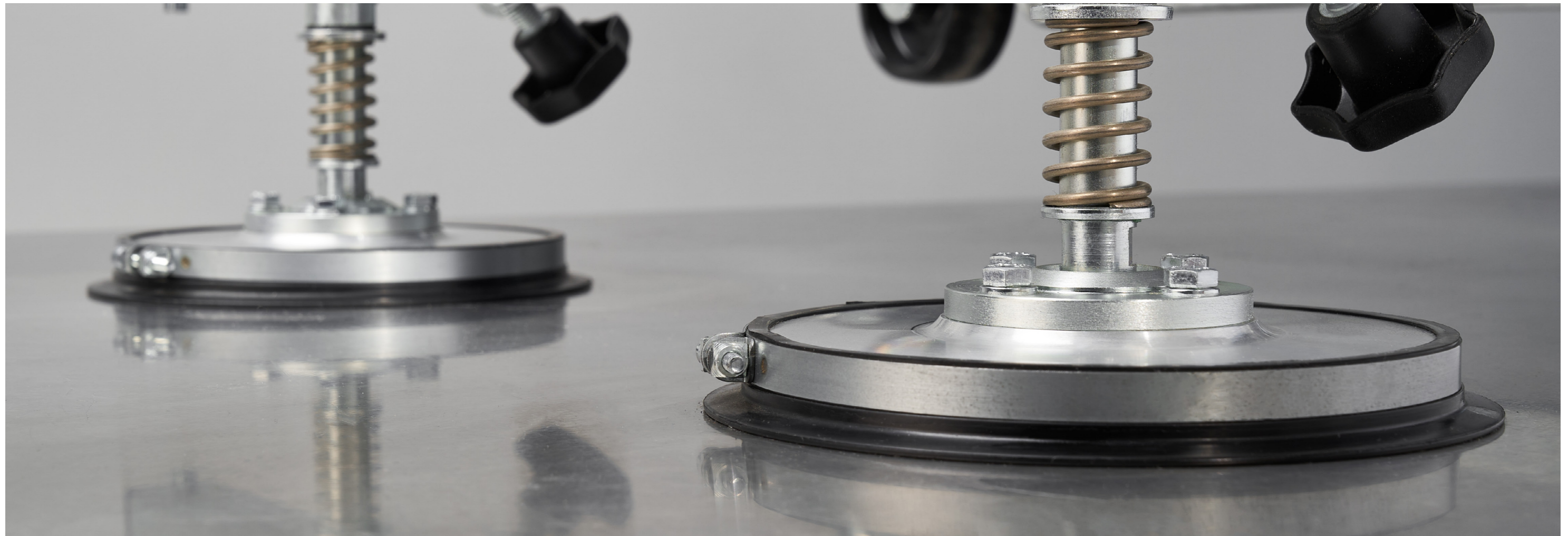

LIFTING DEVICES FOR SHEET METAL/PLASTICS

Material/lifting goods



Barrels



Metal sheets



Plastics



Glass



Panels

THE AERO-BASIC: ADVANTAGES

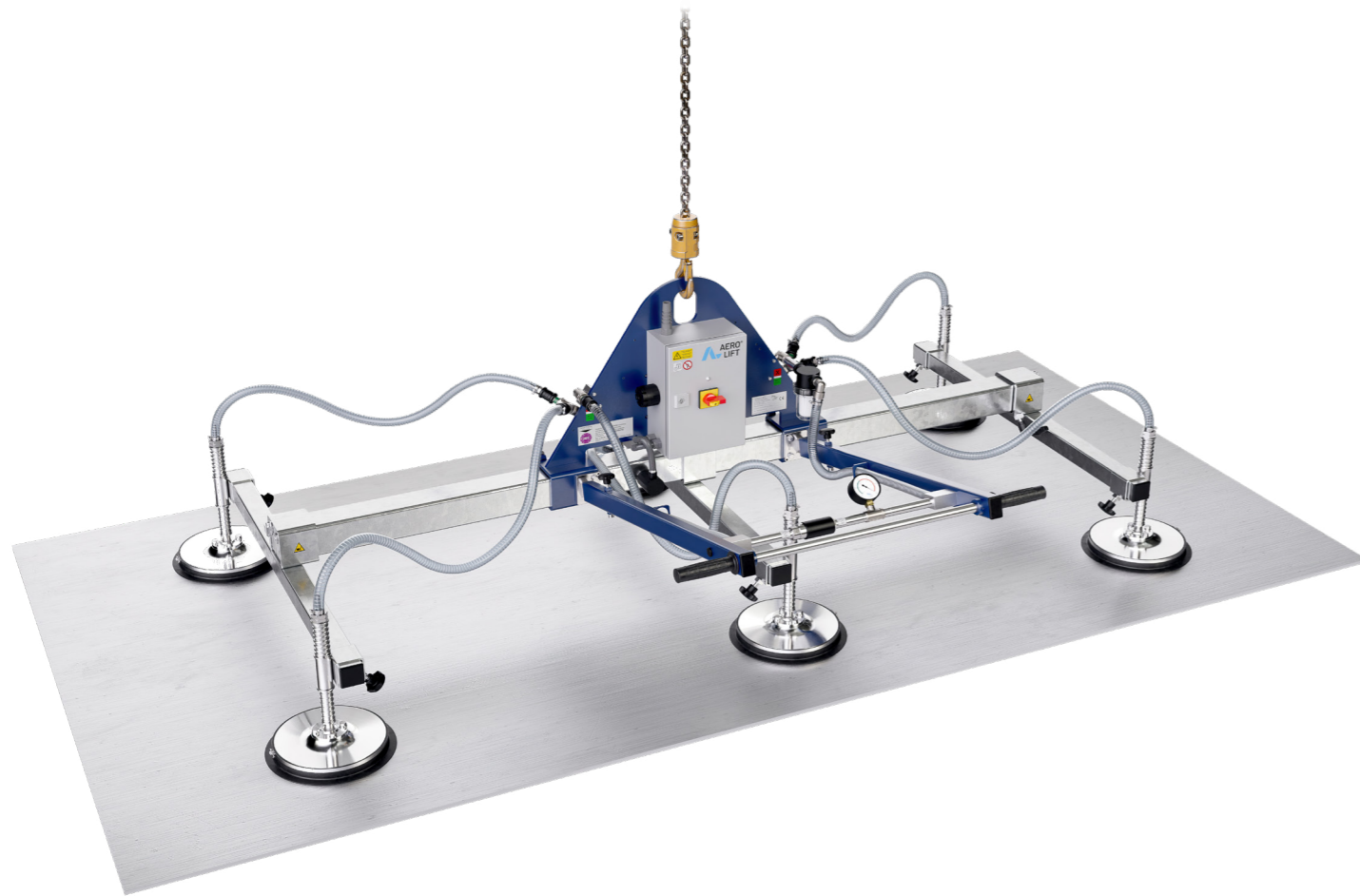

- **Guaranteed work and operator safety** thanks to the generously dimensioned vacuum reservoir with an intelligent warning device
- **Maximum durability thanks to robust welded steel construction** of frame and hot-dip galvanized crossbars
- **Damage-free and gentle transportation** due to the outstanding-quality full elastomer seals with an extremely long service life
- **Unique versatility of the modular basic system**, which can be individually expanded with additional options
- **No downtime** thanks to the integrated motor protection switch, which protects the vacuum generator from winding damage.
- **Short set-up times for different transport good dimensions** because of suction plates that can be individually locked in place using manual slide valves (already included in the basic package)
- **Low operating costs** thanks to the energy-efficient vacuum generator and optional pump control module, which perfectly regulates the activity of the vacuum generator.
- **Quick and easy maintenance:** The intelligent suction plate concept enables worn suction seals to be replaced in seconds with virtually no tools.

AERO-BASIC



< 2,000 kg



Horizontal pick

Material/lifting goods



Metal sheets



Plastics



Panels

Further details about AERO-BASIC



Dimension drawing

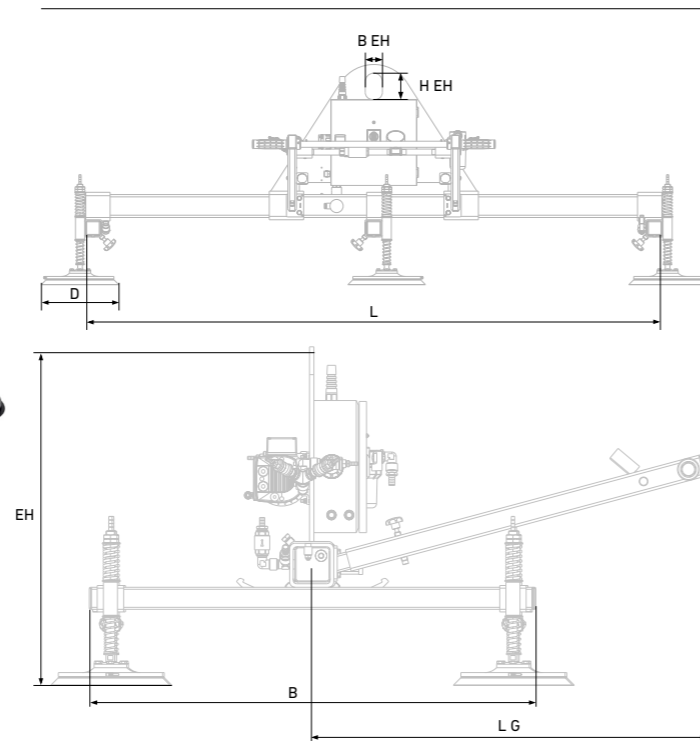
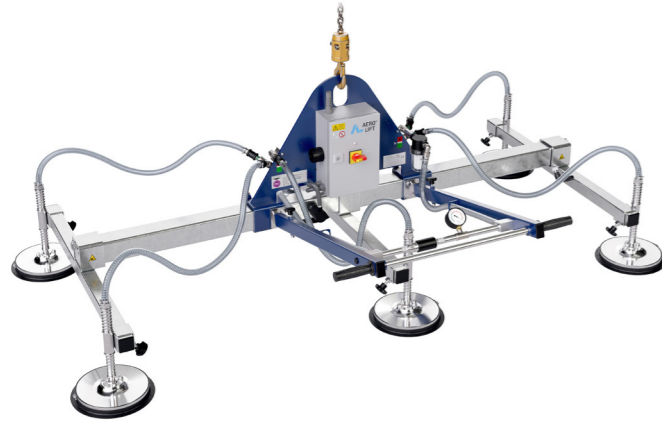

Product data

Load capacity	No. of suction pl.	No. of cross beams	Suction pl. dim.	Main cross beam leng.	Cross beam leng.	Handle length	Mounting eye height/width	Mounting height	Item code
			D	L	B				
[kg]	[pieces]	[pieces]	[mm]	[mm]	[mm]	[mm]	[mm]	[mm]	
150	4	2	170	2,000	1,000	850-1,250	92 x 60	690	AE 150/4R/2000
	6	3	120	2,000	1,000	850-1,250	92 x 60	690	AE 150/6R/2000
400	4	2	210	2,000	1,000	850-1,250	92 x 60	730	AE 400/4R/2000
	6	3	170	2,000	1,000	850-1,250	92 x 60	690	AE 400/6R/2000
600	8	4	170	2,000	1,000	850-1,250	92 x 60	690	AE 400/8R/2000
	4	2	270	2,000	1,000	850-1,250	92 x 60	740	AE 600/4R/2000
900	6	3	210	2,000	1,000	850-1,250	92 x 60	740	AE 600/6R/2000
	8	4	210	2,000	1,000	850-1,250	92 x 60	740	AE 600/8R/2000
1,000	6	3	270	2,000	1,000	850-1,250	92 x 60	740	AE 900/6R/2000
	8	4	270	2,000	1,000	850-1,250	92 x 60	740	AE 900/8R/2000
1,500	6	3	270	2,000	1,000	860-1,260	120 x 80	860	AE 1000/6R/2000
	8	4	270	2,000	1,000	860-1,260	120 x 80	860	AE 1000/8R/2000
2,000	6	3	350	3,000	1,000	860-1,260	120 x 80	870	AE 1500/6R/3000
	8	4	350	3,000	1,000	860-1,260	120 x 80	870	AE 1500/8R/3000
	10	5	270	3,000	1,000	860-1,260	120 x 80	860	AE 1500/10R/3000
	8	4	350	3,000	1,000	860-1,260	120 x 80	870	AE 2000/8R/3000

Optional configuration / Accessories

Designation	Item code suffix	Description
Ecomatic & Safety	-ES	Clearly visible red and green LED lights indicate that the vacuum lifter is ready for use. The Ecomatic pump control module regulates the activity level of the vacuum pump. Depending on the frequency and use of the device, power consumption can be reduced by up to 70%.
Park & Move	-PR	Support feet mounted directly on the device. The height can be varied using a locking bolt. Castors are also used to transport the system.
Hydro	-HY	A water separator protects the vacuum pump from moisture and dirt.
Stacking*	-HE	This module consists of an operating handle that can be adjusted to the operator's position or working height using a Bowden cable. The operating handle can be angled in various stages halfway along its length.
Chain hoist connection	-CH	As an option, the vacuum lifting device can be configured with a spiral cable and a Harting connector instead of a CEE connector. This enables the vacuum lifter to be powered directly at the chain hoist and prevents cables from getting in the way in the working area.
3.0-metre main cross beam**	E.g. "AE 600/6R/3000"	Extension of the main cross beam to 3.0 m to compensate for the overhang at both ends when lifting extra-large sized sheet metal
Holding bag for crane control pendant	-	Adaptation option for the crane control pendant on the device
5 m cable drum	-	Optional cable drum (5 m) for indoor use
10 m cable drum	-	Optional cable drum (10 m) for indoor use

* Only for devices with a load capacity of up to 600 kg (for load capacities over 600 kg on request)

** Only for devices with six or more suction plates

AERO-ADVANCE: ADVANTAGES

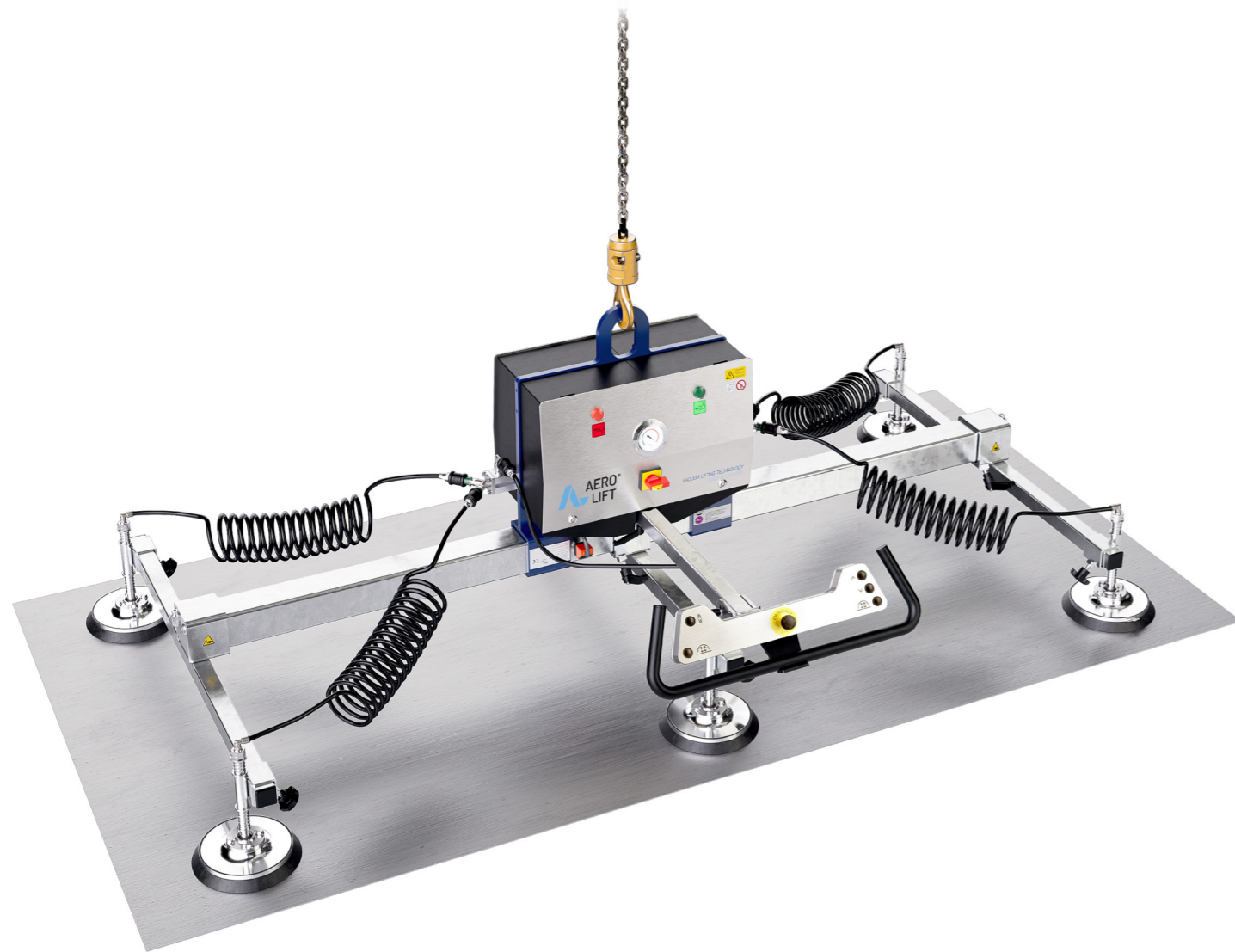

- **Integration of crane control directly on the control panel possible** thanks to optional harmonisation between the chain hoist and the device
- **Suction and release function via a push button** on a modern control panel
- **Maximum process reliability combined with first-class aesthetics** due to its housing made of unbreakable plastic with an aluminium brushed look and hot-dip galvanised steel crossbars
- **Damage-free and gentle transportation** thanks to the outstanding-quality full elastomer seals with an extremely long service life
- **Unrivalled versatility of the modular basic system**, which can be individually expanded with additional options
- **Maximum energy efficiency and therefore low operating costs** because of the integrated pump control module, which ensures intelligent regulation of the vacuum generator.
- **Guaranteed work and operator safety** thanks to the generously dimensioned vacuum reservoir with an intelligent warning device
- **Real-time display of the vacuum level** thanks to LED lights, which provide information about the operational readiness of the system.
- **Short set-up times for different transport good dimensions** due to suction plates that can be individually locked in place using manual slide valves (already included in the basic package)
- **Quick and easy maintenance:** The intelligent suction plate concept enables worn suction seals to be replaced in seconds with virtually no tools.



< 1,000 kg



Horizontal pick

Material/lifting goods



Metal sheets



Plastics



Panels

Further details about AERO-ADVANCE



Dimension drawing

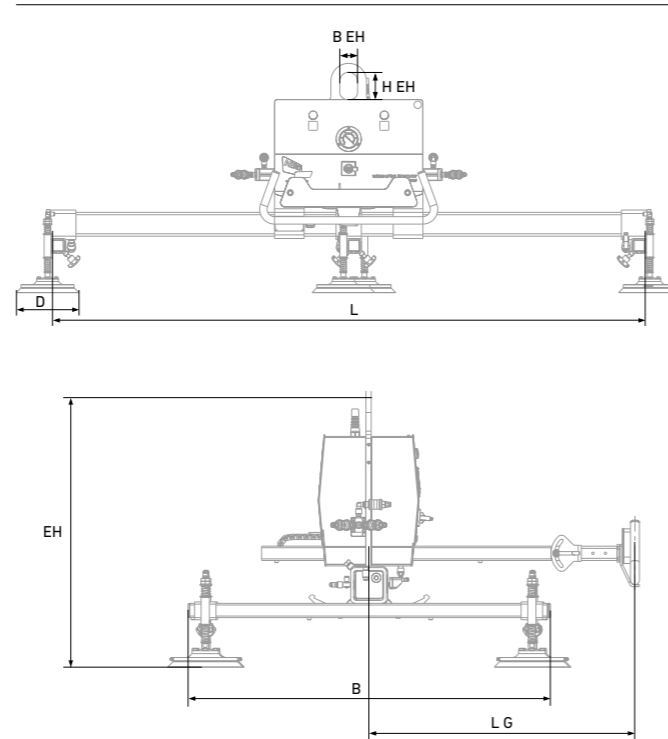

Product data

Load capacity	Number of suction pl.	No. of cross beams	Suction plate dia.	Main cross beam leng.	Cross beam leng.	Handle length	Mounting eye height/width	Mounting height	Item code
			D	L	B	L G	H EH/B EH	EH	
150	4	2	170	2,000	1,000	545 - 945	92 x 60	730	AE-ADVANCE 150/4R/2000
	6	3	120	2,000	1,000	545 - 945	92 x 60	730	AE-ADVANCE 150/6R/2000
400	4	2	210	2,000	1,000	545 - 945	92 x 60	750	AE-ADVANCE 400/4R/2000
	6	3	170	2,000	1,000	545 - 945	92 x 60	730	AE-ADVANCE 400/6R/2000
600	8	4	170	2,000	1,000	545 - 945	92 x 60	730	AE-ADVANCE 400/8R/2000
	4	2	270	2,000	1,000	545 - 945	92 x 60	750	AE-ADVANCE 600/4R/2000
900	6	3	210	2,000	1,000	545 - 945	92 x 60	750	AE-ADVANCE 600/6R/2000
	8	4	210	2,000	1,000	545 - 945	92 x 60	750	AE-ADVANCE 600/8R/2000
1,000	6	3	270	2,000	1,000	545 - 945	92 x 60	750	AE-ADVANCE 900/6R/2000
	8	4	270	2,000	1,000	545 - 945	92 x 60	770	AE-ADVANCE 900/8R/2000
1,000	6	3	270	2,000	1,000	545 - 945	92 x 60	770	AE-ADVANCE 1000/6R/2000
	8	4	270	2,000	1,000	545 - 945	92 x 60	770	AE-ADVANCE 1000/8R/2000

Optional configuration / Accessories

Designation	Item code suffix	Description
Comfort'	-CF	Integration of the crane or chain hoist control (up and down) in the control panel
Hydro	-HY	A water separator protects the vacuum pump from moisture and dirt.
3.0-metre main cross beam"	E.g. "AE ADVANCE 600/6R/3000"	Extension of the main cross beam to 3.0 m to compensate for the overhang at both ends when lifting extra-large sized sheet metal
Park & Move	-PR	Support feet mounted directly on the device. The height can be varied using a locking bolt. Castors are also used to transport the system.
Holding bag for crane control pendant"	-	Adaptation option for the crane control pendant on the device
5 m cable drum"	-	Optional cable drum (5 m) for indoor use
10 m cable drum"	-	Optional cable drum (10 m) for indoor use

* Only in conjunction with the AERO-LIFT chain hoist

** Only for devices with six or more suction plates

*** Only in the basic version (without -CF)

AERO-INDEPEND: ADVANTAGES

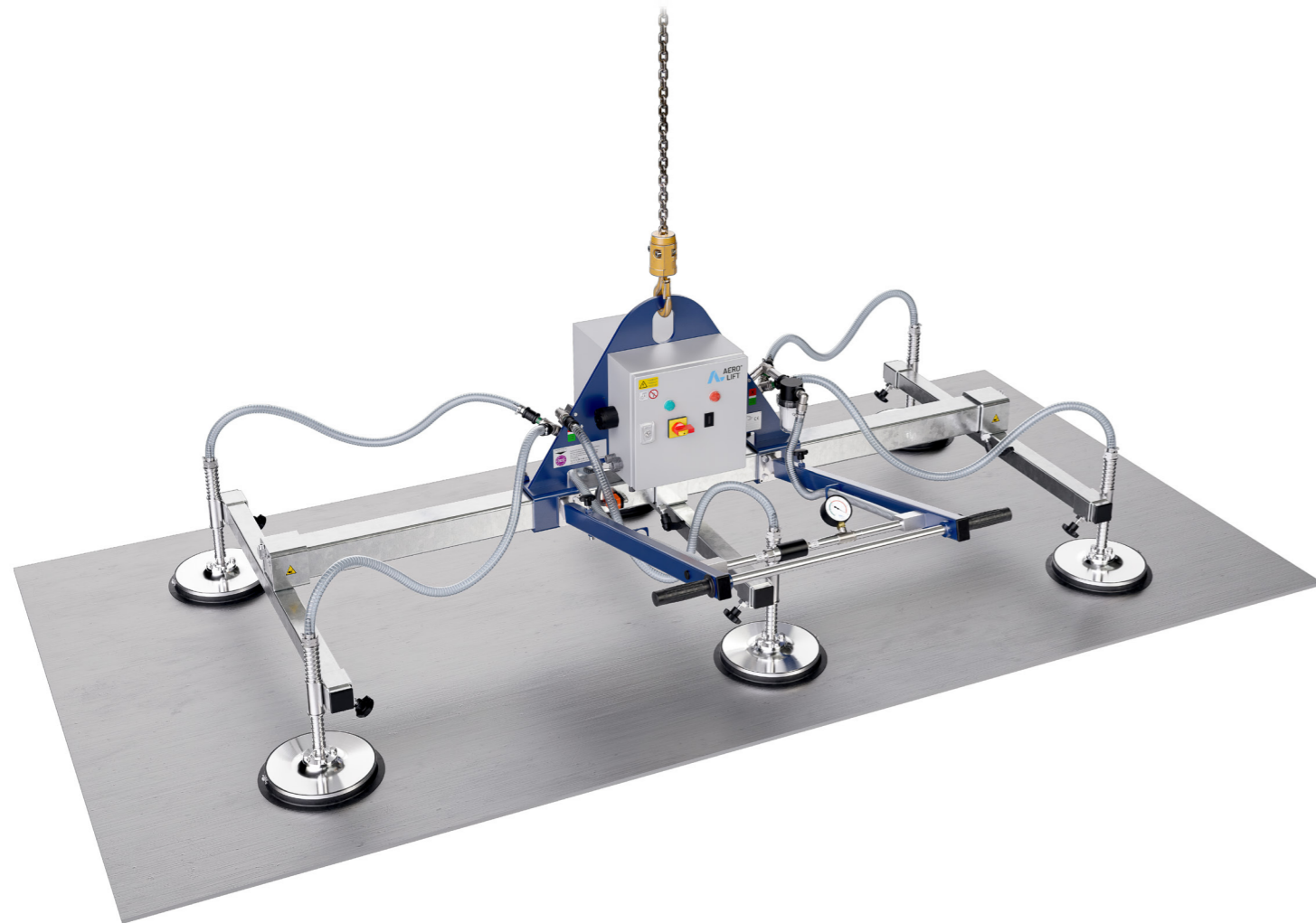

- **Use-dependent/battery-powered version with a guaranteed long battery life** and short charging cycles. The battery status can be seen at all times on the battery indicator.
- **Maximum battery runtimes** thanks to the integrated pump control module, which ensures intelligent regulation of the vacuum generator. (The pump is switched to stand-by mode as soon as the operating vacuum is generated).
- **Real-time display of the vacuum level** due to LED lights, which provide information about the operational readiness of the system.
- **Damage-free and gentle transportation** thanks to the outstanding-quality full elastomer seals with an extremely long service life
- **Maximum process reliability** thanks to the robust welded steel construction of the frame and cross-bars
- **Unrivalled versatility of the modular basic system**, which can be individually expanded with additional options
- **Guaranteed work and operator safety** thanks to the generously dimensioned vacuum reservoir with an intelligent warning device
- **Short set-up times for different transport good dimensions** because of suction plates that can be individually locked in place using manual slide valves (already included in the basic package)
- **Quick and easy maintenance:** The intelligent suction plate concept enables worn suction seals to be replaced in seconds with virtually no tools.

AERO-INDEPEND



< 1,000 kg



up to 150 picks/battery charge



Horizontal pick

Material/lifting goods



Metal sheets



Plastics



Panels

Further details about AERO-INDEPEND



Dimension drawing

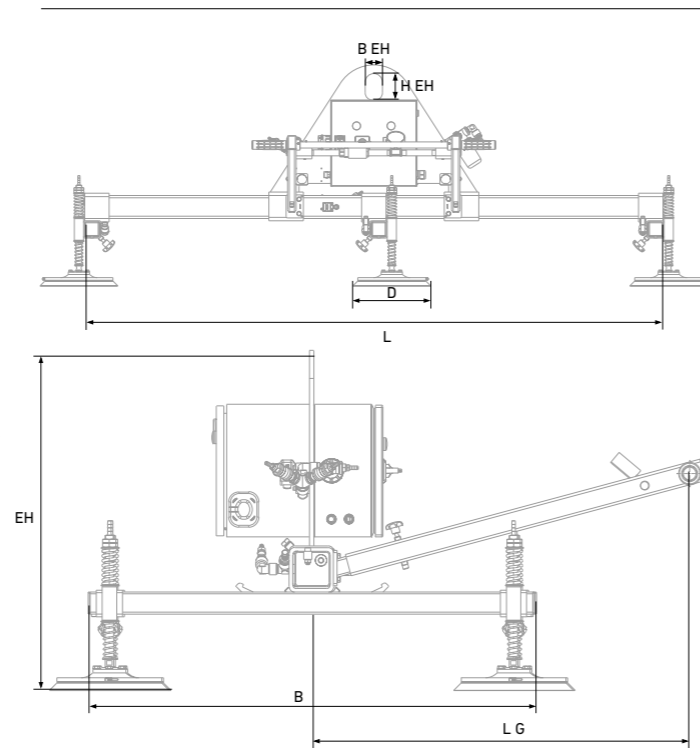

Optional configuration / Accessories

Designation	Item code suffix	Description
Park & Move	-PR	Support feet mounted directly on the device. The height can be varied using a locking bolt. Castors are also used to transport the system.
Hydro	-HY	A water separator protects the vacuum pump from moisture and dirt.
Stacking*	-HE	This module consists of an operating handle that can be adjusted to the operator's position or working height using a Bowden cable. The operating handle can be angled in various stages halfway along its length.
3.0-metre main cross beam**	E.g. "AE INDEPEND 600/6R/3000"	Extension of the main cross beam to 3.0 m to compensate for the overhang at both ends when lifting extra-large sized sheet metal
Holding bag for crane control pendant	-	Adaptation option for the crane control pendant on the device

* Only for devices with a load capacity of up to 600 kg (for load capacities over 600 kg on request)

** Only for devices with six or more suction plates

Product data



Load capacity	Number of suction pl.	No. of cross beams	Suction plate dia.	Main cross beam leng.	Cross beam leng.	Handle length	Mounting eye height/width	Mounting height	Item code
			D	L	B		H EH/B EH		
[kg]	[pieces]	[pieces]	[mm]	[mm]	[mm]	[mm]	[mm]	[mm]	
150	4	2	170	2,000	1,000	850 - 1,250	92 x 60	690	AE-INDEPEND 150/4R/2000
150	6	3	120	2,000	1,000	850 - 1,250	92 x 60	690	AE-INDEPEND 150/6R/2000
400	4	2	210	2,000	1,000	850 - 1,250	92 x 60	730	AE-INDEPEND 400/4R/2000
400	6	3	170	2,000	1,000	850 - 1,250	92 x 60	690	AE-INDEPEND 400/6R/2000
400	8	4	170	2,000	1,000	850 - 1,250	92 x 60	690	AE-INDEPEND 400/8R/2000
600	4	2	270	2,000	1,000	850 - 1,250	92 x 60	740	AE-INDEPEND 600/4R/2000
600	6	3	210	2,000	1,000	850 - 1,250	92 x 60	740	AE-INDEPEND 600/6R/2000
600	8	4	210	2,000	1,000	850 - 1,250	92 x 60	740	AE-INDEPEND 600/8R/2000
900	6	3	270	2,000	1,000	850 - 1,250	92 x 60	740	AE-INDEPEND 900/6R/2000
900	8	4	270	2,000	1,000	850 - 1,250	92 x 60	740	AE-INDEPEND 900/8R/2000
1,000	6	3	270	2,000	1,000	860 - 1,260	120 x 80	860	AE-INDEPEND 1000/6R/2000
1,000	8	4	270	2,000	1,000	860 - 1,260	120 x 80	860	AE-INDEPEND 1000/8R/2000

AERO-SELECT: ADVANTAGES





- **Self-sufficient power pack:** Can be adapted to almost any forklift from well-known manufacturers thanks to the universally adjustable forklift pockets
- **Maximum versatility** as it can be used on both crane hooks and forklift pockets
- **Convenient operation from the driver's cab** as the suction and release process can be controlled by the forklift driver via a remote control panel.
- **Compact design** to maximise the driver's field of vision
- **Real-time display of the vacuum level** thanks to the large all-round lights, which provide information on the operational readiness of the system.
- **Network-independent/battery-powered version with a guaranteed long battery life and short charging cycles.** The battery status can be seen at all times on the battery indicator.
- **Battery-saving and performance-maximising operation** due to the intelligent pump control, which regulates the activity level of the vacuum pump (already included in the basic package).
- **Protection against moisture and dirt** thanks to the integrated water separator
- **Damage-free and gentle transportation** thanks to the outstanding-quality full elastomer seals with an extremely long service life
- **Maximum process reliability** because of the robust welded steel construction of the frame and crossbars
- **Guaranteed work and operator safety** thanks to the generously dimensioned vacuum reservoir with an intelligent warning device
- **Short set-up times for different transport good dimensions** due to suction plates that can be individually locked in place using manual slide valves (already included in the basic package)
- **Quick and easy maintenance:** The intelligent suction plate concept enables worn suction seals to be replaced in seconds with virtually no tools.

AERO-SELECT

 < 2,000 kg
 up to 150 picks/battery charge
 Horizontal pick

Material/lifting goods

 Metal sheets
 Plastics
 Panels

Further details about AERO-SELECT



Dimension drawing

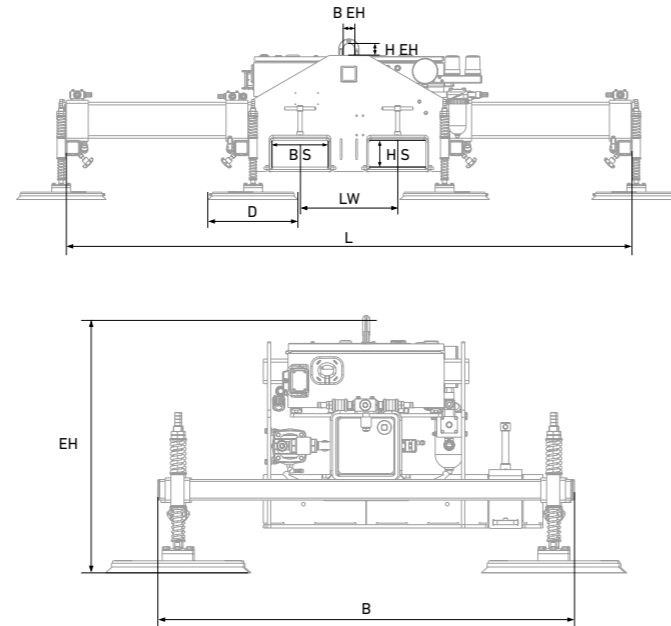

Optional configuration / Accessories

Designation	Item code suffix	Description
 3.0-metre main cross beam*	E.g. "AE SELECT 600/8R/3000"	Extension of the main cross beam to 3.0 m to compensate for the overhang at both ends when lifting extra-large sized sheet metal

* Only for devices with eight suction plates

Product data

Load capacity	No. of suction pt.	Number of cross beams	Suction plate dia.	Main cross beam leng.	Cross beam leng.	Forklift pocket width	Forklift pocket height	Mounting eye height/width	Mounting height	Forklift pocket clear width	Item code
			D	L	B	BS	HS	H EH/B EH	EH	LW	
[kg]	[pieces]	[pieces]	[mm]	[mm]	[mm]	[mm]	[mm]	[mm]	[mm]	[mm]	
150	4	2	170	2,000	1,000	220	100	53x56	545	380	AE-SELECT 150/4R/2000
400	4	2	210	2,000	1,000	220	100	53x56	590	380	AE-SELECT 400/4R/2000
	8	4	170	2,000	1,000	220	100	53x56	545	380	AE-SELECT 400/8R/2000
600	4	2	270	2,000	1,000	220	100	53x56	595	380	AE-SELECT 600/4R/2000
	8	4	210	2,000	1,000	220	100	53x56	595	380	AE-SELECT 600/8R/2000
900	8	4	270	2,000	1,000	220	100	53x56	595	380	AE-SELECT 900/8R/2000
1,000	8	4	270	2,000	1,000	220	100	53x56	595	380	AE-SELECT 1000/8R/2000
1,500	8	4	350	3,000	1,000	220	100	53x56	610	380	AE-SELECT 1500/8R/3000
2,000	8	4	350	3,000	1,000	220	100	53x56	610	380	AE-SELECT 2000/8R/3000

AERO-90°: ADVANTAGES



- **Stepless, smooth swivelling from 0°–90°** thanks to the electric linear drive
- **Damage-free and gentle transportation** thanks to the outstanding quality full elastomer seals with an extremely long service life
- **Maximum process reliability** due to the robust welded steel construction of the frame and crossbars
- **Unrivalled versatility of the modular basic system**, which can be individually expanded with additional options
- **No downtime** because of the integrated motor protection switch, which protects the vacuum generator from winding damage.
- **Guaranteed work and operator safety** thanks to the generously dimensioned vacuum reservoir with an intelligent warning device
- **Short set-up times** for different transport good dimensions thanks to suction plates that can be individually locked in place using manual slide valves (already included in the basic package)
- **Low operating costs** thanks to the energy-efficient vacuum generator and optional pump control module, which perfectly regulates the activity of the vacuum generator.
- **Quick and easy maintenance:** The intelligent suction plate concept enables worn suction seals to be replaced in seconds with virtually no tools.

AERO-90°

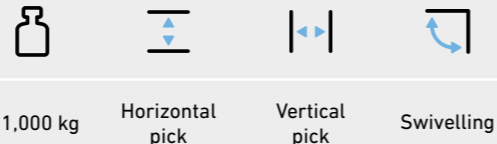

Material/lifting goods



Further details about AERO-90°



Dimension drawing

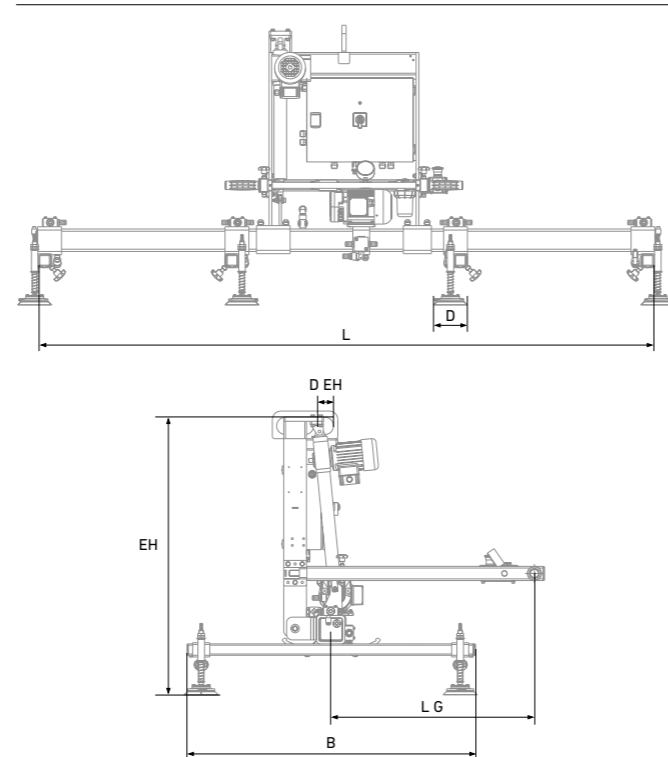

Product data

Load capacity	No. of suction pl.	Number of cross beams	Suction plate dia.	Main cross beam leng.	Cross beam leng.	Handle length	Mounting eye dia.	Mounting height	Item code
			D	L	B	L G	D EH	EH	
125	4	2	170	2,000	1,000	713	60	1,100	AE-90° 125/4R/2000
	8	4	120	2,000	1,000	713	60	1,100	AE-90° 125/8R/2000
250	4	2	270	2,000	1,000	713	60	1,100	AE-90° 250/4R/2000
	8	4	170	2,000	1,000	713	60	1,100	AE-90° 250/8R/2000
500	4	2	350	2,000	1,000	713	60	1,100	AE-90° 500/4R/2000
	8	4	270	2,000	1,000	713	60	1,100	AE-90° 500/8R/2000
1,000	8	4	350	2,000	1,000	703	60	1,240	AE-90° 1000/8R/2000

Optional configuration / Accessories

Designation	Item code suffix	Description
Ecomatic & Safety	-ES	Clearly visible red and green LED lights indicate that the vacuum lifter is ready for use. The Ecomatic pump control module regulates the activity level of the vacuum pump. Depending on the frequency and use of the device, power consumption can be reduced by up to 70%.
Hydro	-HY	A water separator protects the vacuum pump from moisture and dirt.
Chain hoist connection	-CH	As an option, the vacuum lifting device can be configured with a spiral cable and a Harting connector. This enables the vacuum lifter to be powered directly at the chain hoist and prevents cables from getting in the way in the working area.
3.0-metre main cross beam*	E.g. "AE-90° 600/8R/3000"	Extension of the main cross beam to 3.0 m to compensate for the overhang at both ends when lifting extra-large sized sheet metal
Holding bag for crane control pendant	-	Adaptation option for the crane control pendant on the device
5 m cable drum	-	Optional cable drum (5 m) for indoor use
10 m cable drum	-	Optional cable drum (10 m) for indoor use

* Only for devices with eight suction plates

AERO-180°: ADVANTAGES



- **Stepless, smooth turning/swivelling from 0°-180°** thanks to the electric swivel drive
- **Damage-free and gentle transportation** thanks to the outstanding-quality full elastomer seals with an extremely long service life
- **Maximum process reliability** due to the robust welded steel construction of the frame and crossbars
- **Unrivalled versatility of the modular basic system**, which can be individually expanded with additional options
- **No downtime** thanks to the integrated motor protection switch, which protects the vacuum generator from winding damage.
- **Guaranteed work and operator safety** because of the generously dimensioned vacuum reservoir with an intelligent warning device
- **Short set-up times for different transport good dimensions** thanks to suction plates that can be individually locked in place using manual slide valves (already included in the basic package)
- **Low operating costs** due to the energy-efficient vacuum generator and optional pump control module, which perfectly regulates the activity of the vacuum generator.
- **Quick and easy maintenance:** The intelligent suction plate concept enables worn suction seals to be replaced in seconds with virtually no tools.

AERO-180°



Material/lifting goods

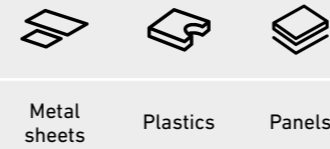

Further details about AERO-180°



Dimension drawing

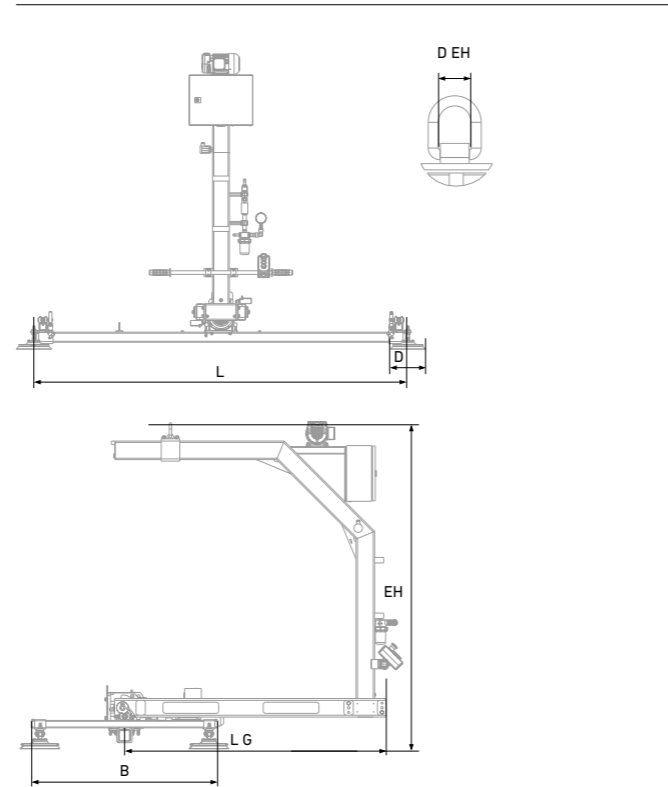

Product data

Load capacity	No. of suction pl.	Number of cross beams	Suction plate dia.	Main cross beam leng.	Cross beam leng.	Handle length	Mounting eye size	Mounting height	Item code
			D	L	B	L G	D EH	EH	
[kg]	[pieces]	[pieces]	[mm]	[mm]	[mm]	[mm]	[mm]	[mm]	
125	4	2	170	2,000	1,000	1,400	39 x 44	1,835	AE-180° 125/4R/2000
	8	4	120	2,000	1,000	1,400	39 x 44	1,835	AE-180° 125/8R/2000
250	4	2	270	2,000	1,000	1,400	39 x 44	1,835	AE-180° 250/4R/2000
	8	4	170	2,000	1,000	1,400	39 x 44	1,835	AE-180° 250/8R/2000

Optional configuration / Accessories

Designation	Item code suffix	Description
Ecomatic & Safety	-ES	Clearly visible red and green LED lights indicate that the vacuum lifter is ready for use. The Ecomatic pump control module regulates the activity level of the vacuum pump. Depending on the frequency and use of the device, power consumption can be reduced by up to 70%.
Hydro	-HY	A water separator protects the vacuum pump from moisture and dirt.
Chain hoist connection	-CH	As an option, the vacuum lifting device can be configured with a spiral cable and a Harting connector. This enables the vacuum lifter to be powered directly at the chain hoist and prevents cables from getting in the way in the working area.
3.0-metre main cross beam*	E.g. "AE-180° 600/8R/3000"	Extension of the main cross beam to 3.0 m to compensate for the overhang at both ends when lifting extra-large sized sheet metal
Holding bag for crane control pendant	-	Adaptation option for the crane control pendant on the device
5 m cable drum	-	Optional cable drum (5 m) for indoor use
10 m cable drum	-	Optional cable drum (10 m) for indoor use

* Only for devices with eight suction plates

LIFTING DEVICES FOR SHEET METAL/PLASTICS



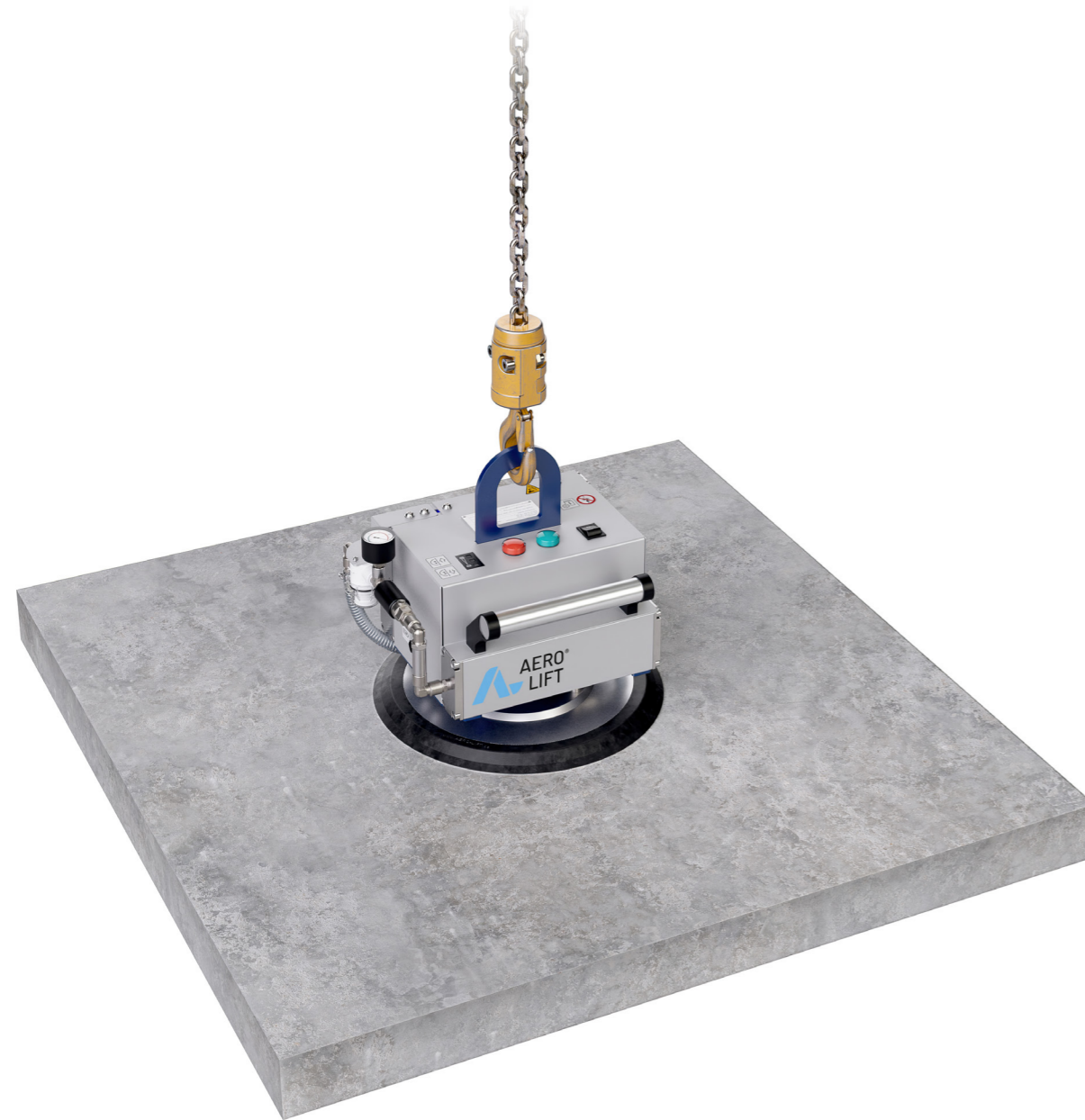

LIFTING DEVICES FOR SHEET METAL/PLASTICS

AERO-CUBE: ADVANTAGES







- **Compact, handy and yet extremely hard-wearing design:** A high-quality aluminium housing accommodates all the components that need to be protected from external influences.
- **Highest energy efficiency and maximally optimised battery life** because of the integrated "Ecomatic" pump control module, which regulates the vacuum level of the vacuum generator.
- **Versatile** thanks to the two suspension eyes that enable horizontal and vertical mounting and movement.
- **Real-time display of the vacuum level** thanks to LED lights, which provide information about the operational readiness of the system.
- **Convenient handling** due to the lightweight design that allows users to transport and set down the device by hand.
- **Intuitive, self-explanatory operation**
- **Customisable to individual requirements** through the use of different sealing materials
- **Guaranteed occupational health and safety compared to self-priming devices:** The battery operation ensures that the vacuum is maintained for several minutes by pumping. In addition, the integrated warning device alerts the operator in good time in the event of a vacuum loss.

AERO-CUBE

 < 250 kg
 up to 150 picks/battery charge
 Horizontal pick
 Vertical pick

Material/lifting goods

 Barrels
 Metal sheets
 Plastics
 Glass
 Panels

Further details about AERO-CUBE



Dimension drawing

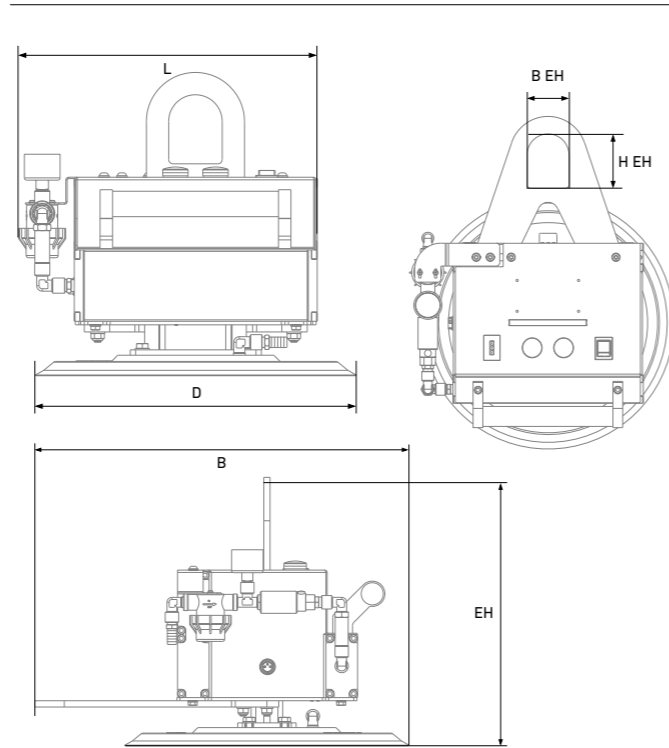

Product data

Horizontal load capacity	Vertical load capacity	Unladen weight	Suction plate dia.	Total length	Total width	Mounting eye height/width	Mounting height	Item code
			D	L	B	H EH/B EH	EH	
[kg]	[kg]	[kg]	[mm]	[mm]	[mm]	[mm]	[mm]	
90	45	18	245	330	420	78 x 60	350	AE-CUBE 90/1M
135	67.5	19	270	330	420	78 x 60	350	AE-CUBE 135/1R
145	72.5	20	300	330	420	78 x 60	350	AE-CUBE 145/1M
250	125	24	360	330	420	78 x 60	320	AE-CUBE 250/1G

Optional configuration / Accessories

Designation	Item code suffix	Description
 Quick Change	-QC	Optional quick-change version for fast suction plate replacement

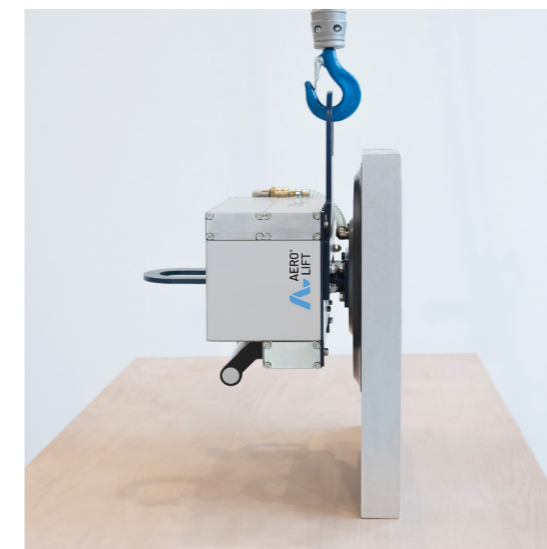

LIFTING DEVICES FOR SHEET METAL/PLASTICS

LIFTING DEVICES FOR SHEET METAL/PLASTICS



LIFTING DEVICES FOR WOOD

Material/lifting goods



Porous panels



Timbers

AERO-PORO: ADVANTAGES



- **Can handle any panel material**, regardless of whether it is air-permeable or closed, e.g. MDF or OSB panels
- **Perfect suction behaviour and an extremely long service life** thanks to the unique sealing concept
- **Stepless and smooth swivelling** possible in addition to horizontal handling thanks to the optional 90° swivel gearbox
- **Easy replacement and rotation (90°) of the suction plates** due to the mechanical connection with the galvanised steel adapter plates
- **Maximum process reliability** thanks to the robust welded steel construction of the frame and crossbars
- **Easy suction and releasing** of heavy panels at the touch of a button on the control panel
- **Maximum user safety** and an extremely long service life thanks to the powerful vacuum blower with overrunning flywheel mass
- **No downtime** because of the integrated motor protection switch, which protects the vacuum generator from winding damage.

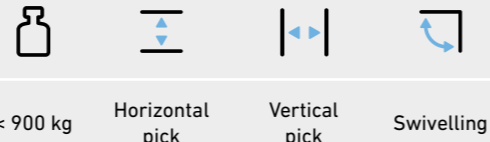

Dimension drawing

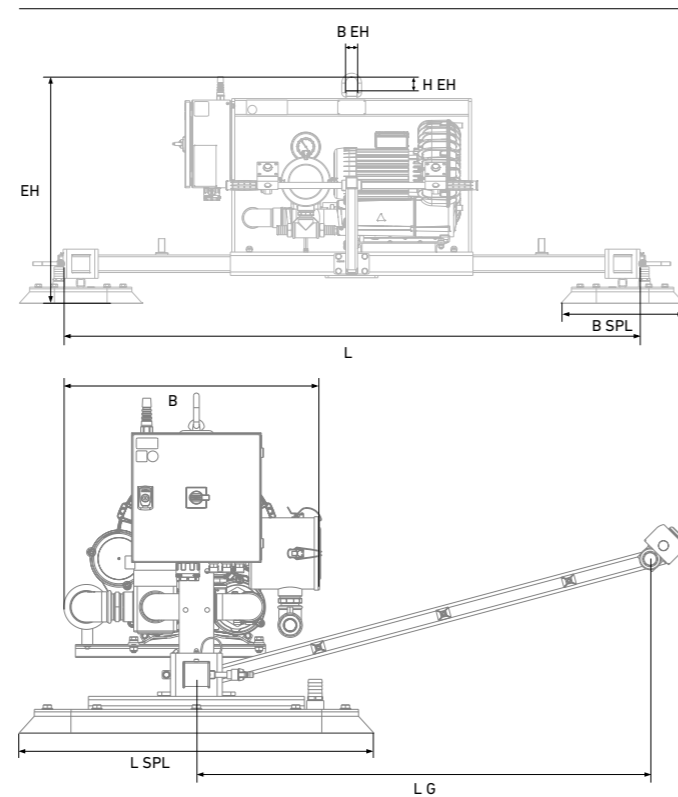

Product data

Load capacity*	No. of suction pl.	Suction pl. length	Suction pl. width	Main cross beam leng.	Total width	Handle length	Mounting eye height/width	Mounting height	90° swivelling movement	Item code
		L SPL	B SPL		L					
[kg]	[pieces]	[pieces]	[mm]	[mm]	[mm]	[mm]	[mm]	[mm]		
300	1	820	420	1,000	1,050	720	48 x 42	766	-	AE-PORO 300/1L
600	2	820	420	2,000	1,050	720	48 x 42	763	-	AE-PORO 600/2L/2000
900	3	820	420	2,000	1,050	720	48 x 42	763	-	AE-PORO 900/3L/2000
300	2	820	420	2,000	932 - 1,697	850 - 1,700	∅ 60	699	✓	AE-PORO-90° 300/2L/2000
450	3	820	420	2,000	932 - 1,697	850 - 1,700	∅ 60	690	✓	AE-PORO-90° 450/3L/2000

* Depending on the porosity of the transport goods, the load capacity may be reduced.

Optional configuration / Accessories

Designation	Item code suffix	Description
Inlay panels for MDF	-FG	Thanks to the additional inlay panels, even fragile materials such as MDF boards can be lifted. The volume within the suction plate is reduced and thus the pressure exerted on the workpiece decreases.
Chain hoist connection	-CH	As an option, the vacuum lifting device can be configured with a spiral cable and a Harting connector. This enables the vacuum lifter to be powered directly at the chain hoist and prevents cables from getting in the way in the working area.
5 m cable drum	-	Optional cable drum (5 m) for indoor use
10 m cable drum	-	Optional cable drum (10 m) for indoor use
Holding bag for crane control pendant	-	Adaptation option for the crane control pendant on the device

AERO-TIMBER: ADVANTAGES



- **Can handle long material up to 13 m in length**, e.g. for glulam, solid structural timber and rough-sawn beams
- **Guaranteed work and operator safety** because of the generously dimensioned vacuum reservoir with an intelligent warning device
- **Optimally adapted to the working environment** thanks to the selectable handle position (transversely and at the front)
- **Quick and easy maintenance:** The intelligent suction plate concept enables worn suction seals to be replaced in seconds without tools.
- **High process accuracy** when placing the vacuum lifter on the transport goods thanks to the positioning aids on all suction plates
- **Can handle beams with a width of 8 cm or more** due to a specially designed suction plate concept with three vacuum chambers
- **Maximum process reliability** thanks to the robust welded steel construction of the frame and crossbars
- **Unrivalled versatility of the modular basic system** with an integrated water separator, which can be individually expanded with additional options



< 600 kg



Horizontal pick



Timbers



Dimension drawing

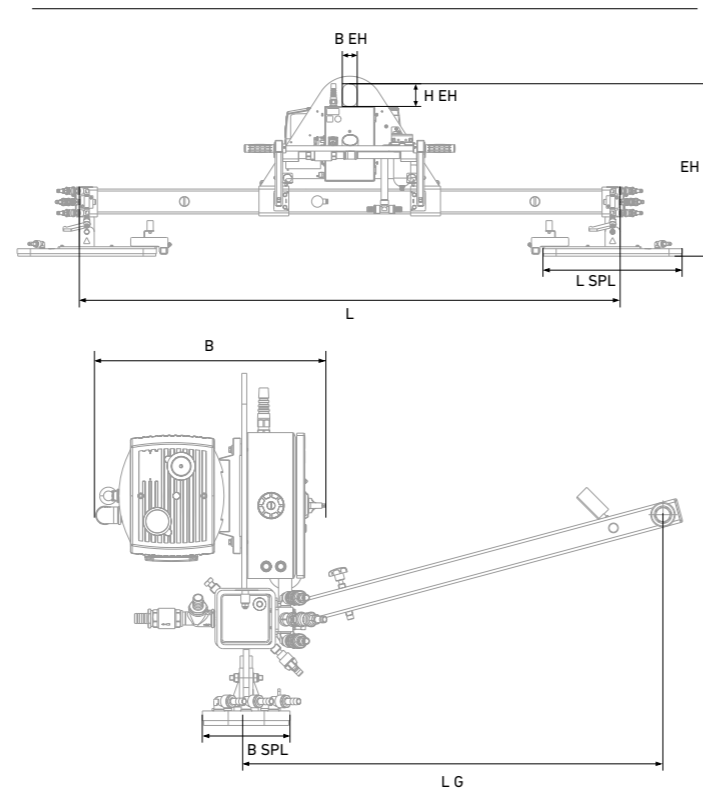

Product data

Load capacity	No. of suction pl.	Suction pl. length	Suction pl. width	Main cross beam leng.	Total width	Handle length	Mounting eye height/width	Mounting height	Handle version	Item code
		L SPL	B SPL				L			
300	2	560	180	2,000	350	1,500 - 2,000	92 x 60	724	front	AE-TIMBER 300/2M3K/2000-ST-HY
	2	560	180	2,000	480	900 - 1,280	92 x 60	724	horizontal	AE-TIMBER 300/2M3K/2000-HY
600	4	560	180	4,000	350	1,500 - 2,000	120 x 80	959	front	AE-TIMBER 600/4M3K/4000-ST-HY
	4	560	180	4,000	480	900 - 1,280	120 x 80	959	horizontal	AE-TIMBER 600/4M3K/4000-HY

Optional configuration / Accessories

Designation	Item code suffix	Description
Park & Move	-PR	Support feet mounted directly on the device. The height can be varied using a locking bolt. Castors are also used to transport the system. The ideal feature for parking the system while it is not in use.
Chain hoist connection	-CH	As an option, the vacuum lifting device can be configured with a spiral cable and a Harting connector. This enables the vacuum lifter to be powered directly at the chain hoist and prevents cables from getting in the way in the working area.
5 m cable drum	-	Optional cable drum (5 m) for indoor use
10 m cable drum	-	Optional cable drum (10 m) for indoor use
Holding bag for crane control pendant	-	Adaptation option for the crane control pendant on the device

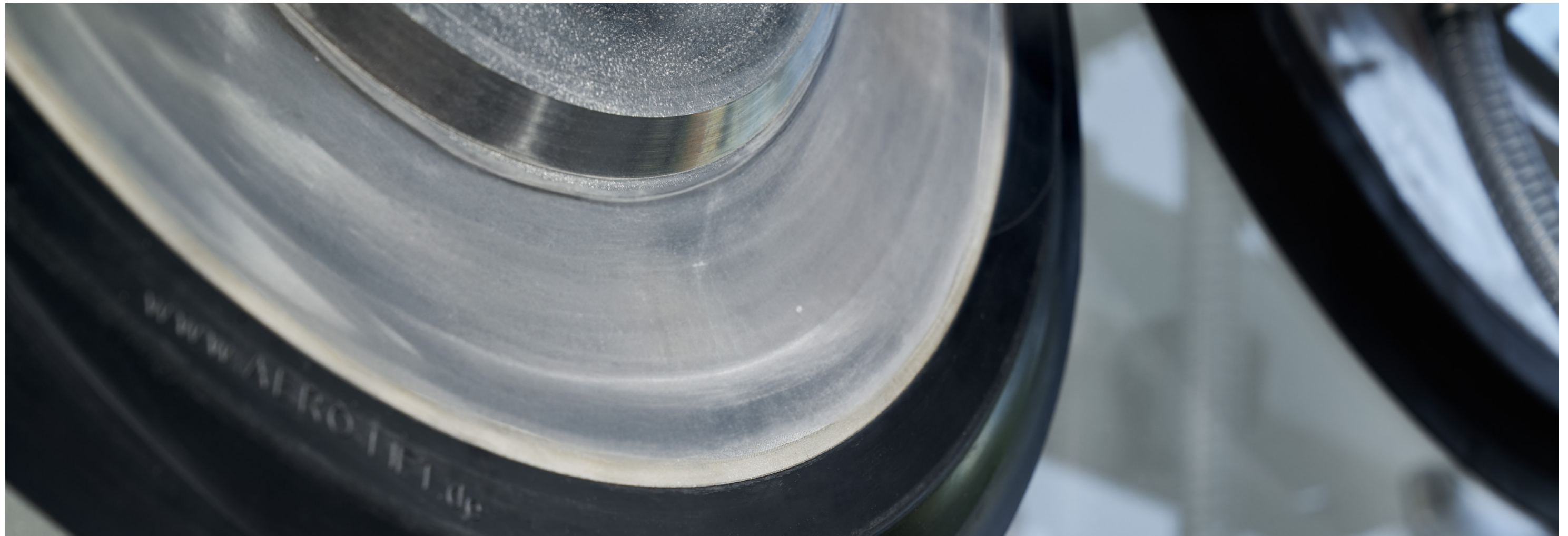

LIFTING DEVICES FOR GLASS

Material/lifting goods



Glass

AERO-WINDOW: ADVANTAGES



- **Can handle smooth transport goods**, such as glass and windows
- **Excellent suction properties and increased friction coefficient in the vertical position** thanks to the special AERO-LIFT glass suction plates with a low intrinsic volume and a special structure
- **Centre of gravity compensation for different transport good weights** due to the 3-hole suspension eye
- **All of the suction plates can be switched on and off in a matter of seconds** via manual slide valves and/or quick-change couplings
- **Quick and tool-free conversion guaranteed** thanks to plug-in connections that enable configuration with fewer or more suction plates. In addition, two of the four crossbars can be removed and adapted to different load sizes.
- **Maximum compactness and optimised unladen weight of the device** because the vacuum accumulator is integrated in the frame
- **Rotation of the workpiece in the vertical direction by +/- 90° and fixing every 90°** by means of a Bowden cable
- **No downtime** because of the integrated motor protection switch, which protects the vacuum generator from winding damage.
- **Quick and easy maintenance:** The intelligent suction plate concept enables worn suction seals to be replaced in seconds with no tools.

 < 500 kg
  Vertical pick
  Rotating

Material/lifting goods



Glass

Further details
about AERO-WINDOW



Dimension drawing

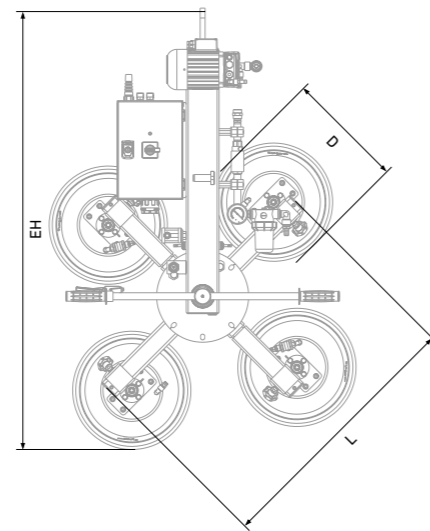

Optional configuration / Accessories

Designation	Item code suffix	Description
 Chain hoist connection	-CH	As an option, the vacuum lifting device can be configured with a spiral cable and a Harting connector. This enables the vacuum lifter to be powered directly at the chain hoist and prevents cables from getting in the way in the working area.

Product data

Load capacity	No. of suction pl.	Number of cross beams	Suction plate dia.	Cross beam leng. (max.)	Mounting eye dia.	Mounting height	Item code
			D	L		EH	
[kg]	[pieces]	[pieces]	[mm]	[mm]	[mm]	[mm]	
300	4	4	270	800	85	1,280	AE-WINDOW 300/4G
500	4	4	360	800	85	1,280	AE-WINDOW 500/4G

AERO-VARIOWIN: ADVANTAGES



- **The problem solver for glass in prefabricated house construction**
- **Excellent suction properties and increased friction coefficient in the vertical position** thanks to the special AERO-LIFT glass suction plates with a low intrinsic volume and a special structure
- **Can handle workpieces with a web offset of up to max. 13 cm** due to the depth-adjustable suction plates
- **Can avoid interfering contours, such as soffits or frames**, thanks to the height-adjustable suspension points
- **Easy transport of tall workpieces in an upright position** because of the extra-long suspension frame
- **Balanced load distribution** thanks to the adjustable centre of gravity compensation on the suspension frame
- **Safe storage option for vacuum lifters and attachments** due to the transport rack included in the scope of delivery
- **Possibility of handling smaller formats** thanks to the additional shorter crane suspension
- **Highest safety standards** thanks to the integrated tandem vacuum reservoir mounted on both sides of the frame and the additional acoustic and visual warning signals
- **Rotation of the workpiece in the vertical direction by +/-90° and fixing every 15°** by means of a Bowden cable
- **Quick and tool-free conversion guaranteed** because of plug-in connections that enable configuration with fewer or more suction plates.
- **Includes frame for safe transport**
- **No downtime** thanks to the integrated motor protection switch, which protects the vacuum generator from winding damage.
- **Quick and easy maintenance:** The intelligent suction plate concept enables worn suction seals to be replaced in seconds with no tools.

 < 500 kg
  Vertical pick
  Rotating

Material/lifting goods



Glass

Further details about AERO-VARIOWIN



Dimension drawing

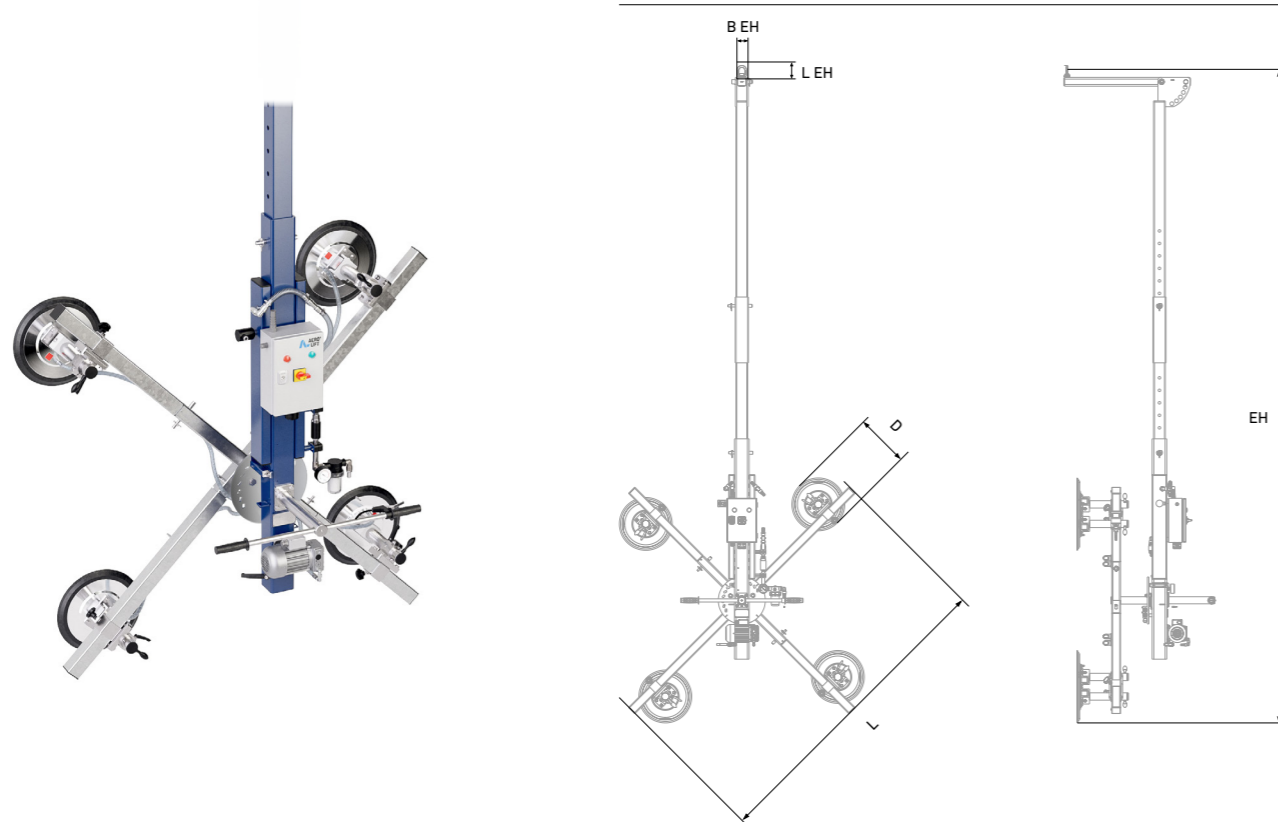

Optional configuration / Accessories

	Designation	Item code suffix	Description
	Chain hoist connection	-CH	As an option, the vacuum lifting device can be configured with a spiral cable and a Harting connector. This enables the vacuum lifter to be powered directly at the chain hoist and prevents cables from getting in the way in the working area.

Product data

Load capacity	No. of suction pl.	Number of cross beams	Suction plate dia.	Cross beam leng. (max.)	Mounting eye width	Mounting eye length	Mounting height	Item code
			D	L	B EH	L EH	EH	
[kg]	[pieces]	[pieces]	[mm]	[mm]	[mm]	[mm]	[mm]	
250	4	2	270	1,625	25	36	3,280	AE-VARIOWIN 250/4G
500	4	2	360	2,110	25	36	4,580	AE-VARIOWIN 500/4G

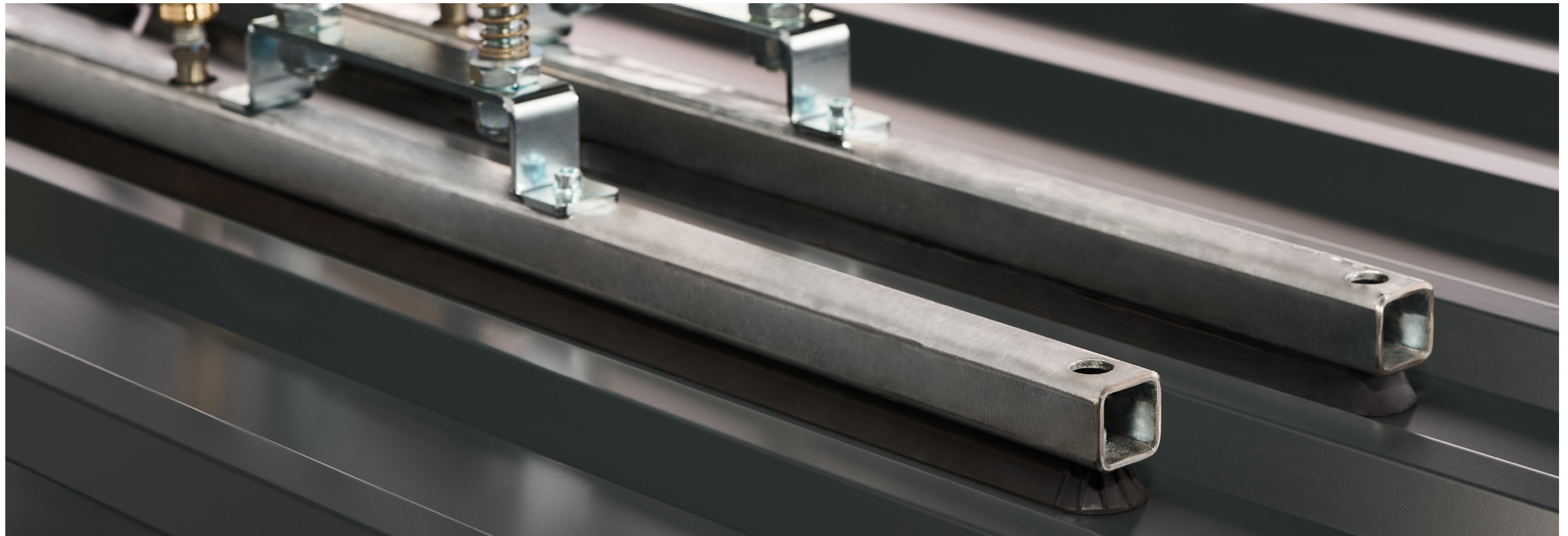

LIFTING DEVICES FOR CLADDING (OUTDOOR)

Material/lifting goods



Sandwich elements



Trapezoidal sheets

CLAD-BOY: ADVANTAGES



- **CLAD-BOY – the original! Specially designed for use on construction sites:** The CLAD-BOY is absolutely weatherproof, extremely resistant to impact and also impresses with its low unladen weight.
- **Covers all tasks on the construction site** thanks to the all-rounder suction plates, which can handle all types of sandwich elements and trapezoidal sheets for facades and roofs.
- **Versatile and robust,** suitable for both roof and wall mounting
- **Maximum versatility and tool-free conversion** due to the modular and pluggable, hot-dip galvanised main cross beams
- **Long running and short charging times** thanks to the battery-powered vacuum generator
- **Up to 70 % longer battery life** thanks to the Eco-matic pump control module included as standard, which ensures intelligent activity control measured by the vacuum level.
- **Highest safety standards** because of an audible and visual warning signal when the battery is low and/or the vacuum level drops
- **70–80 % longer service life than conventional products** thanks to the tried-and-tested, quickly replaceable and UV-resistant suction plates
- **Convenient transport and storage options** for all attachments and the vacuum lifter thanks to the specially designed STORE-BOY XL storage unit, which also includes an equipment box for stowing all tube or suction plate components.

CLAD-BOY

 < 500 kg
 up to 150 picks/battery charge
 Horizontal pick
 Vertical pick
 Swivelling

Material/lifting goods

 Sandwich elements
 Trapezoidal sheets





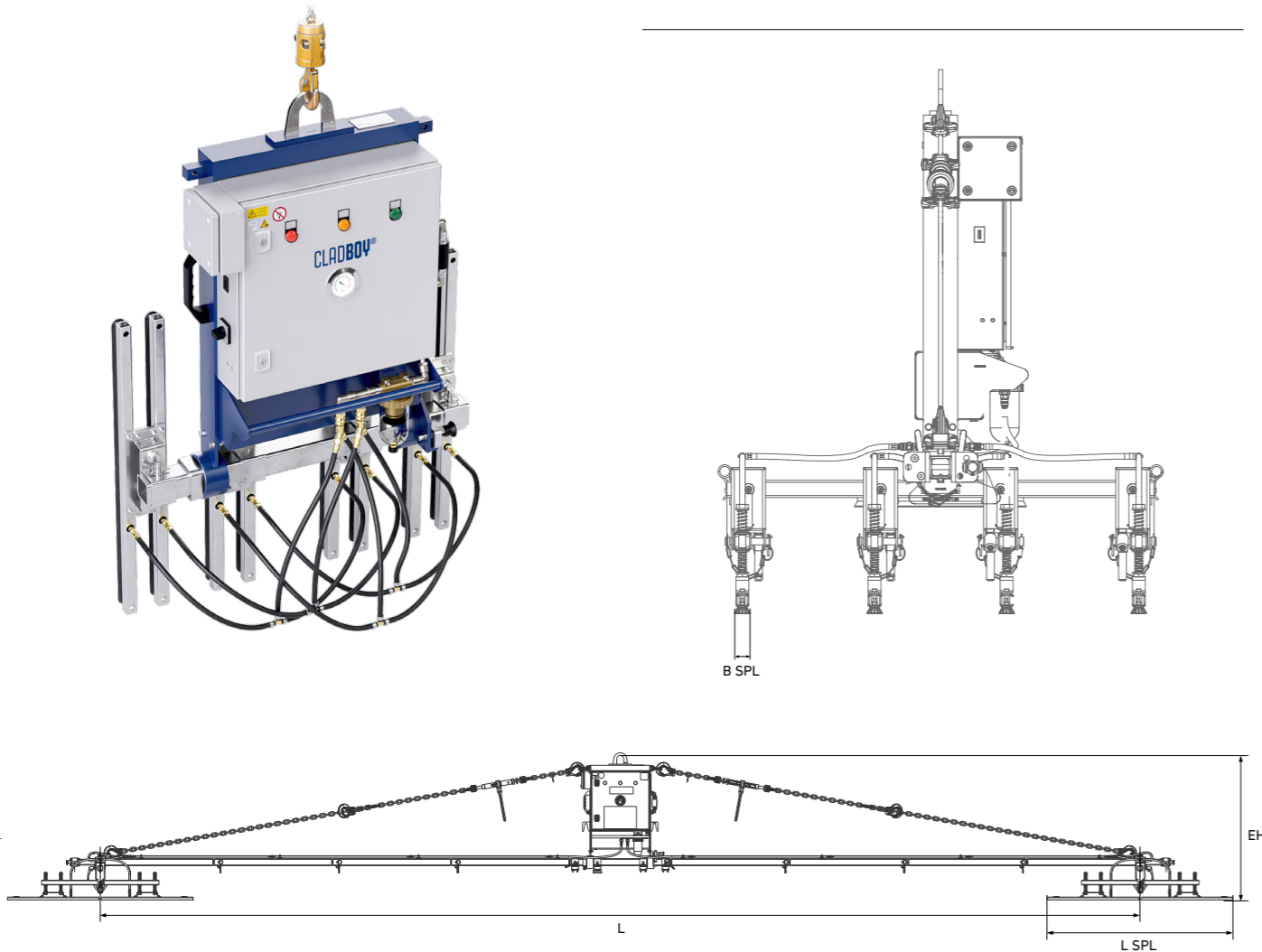

Further details about CLAD-BOY



Dimension drawing



Optional configuration / Accessories

Designation	Item code	Description
 STORE-BOY XL	SBXL-CB-1210x780	The add-on for smart, safe and affordable transport, can also be used as a mounting frame
 Cross beam for roof and wall	KT-DW-90°	For installing panel elements with a higher angle of inclination
 Suction plate holder for horizontal wall mounting*	SPLH-WH-CB-80x400	Recommended for cushioning
 Suction plate holder for vertical wall mounting*	SPLH-WV-CB-80x400	Recommended for cushioning
 Sponge rubber suction plate 80x600 mm	SPL-CB-80x600M	Compensates for higher structural unevenness (beading)
 Protective covers for 80x400 mm suction plate	SUEZ-CB-80x400	Recommended for protecting the 80x400 mm suction plate during transport
 Protective covers for 36x780 mm all-rounder suction plate	SUEZ-CB-36x780	Recommended for protecting the 36x780 mm suction plate during transport

* Only in combination with the 80x400 mm suction plate

You can bring our previous CLAD-BOY versions up to date with the upgrade kit:

 Upgrade kit with 8 all-rounder suction plates	UK-CB-8L/36x780	Universal suction plate that covers every type of panel and installation.
---	-----------------	---

Product data

Load capacity		No. of suction pl.	Suction plate dimensions		Mounting height	Cross beam leng. (max.)	Max. transport goods length	Roof	Horizontal wall ¹	Vertical wall ²	Item code
horizontal	vertical		B SPL	L SPL							
[kg]	[kg]	[pieces]	Width [mm]	Length [mm]	Height [mm]	[mm]	[mm]				
300	240	6	80	400	1,167	2,870	12,000	✓	✓	✓	CLAD-BOY 300/6L/2870
300	240	6	80	400	1,167	4,890	14,000	✓	(✓)	(✓)	CLAD-BOY 300/6L/4890
300	240	6	80	400	1,167	8,930	18,000	✓	(✓)	(✓)	CLAD-BOY 300/6L/8930
350	240	8	36	780	1,254	4,890	14,000	✓	(✓)	(✓)	CLAD-BOY 350/8L/4890
350	240	8	36	780	1,254	8,930	18,000	✓	(✓)	(✓)	CLAD-BOY 350/8L/8930
500	240	16	36	780	1,254	8,930	18,000	✓	(✓)	(✓)	CLAD-BOY 500/16L/8930

¹ See option: SPLH-WH-CB-80x400 | ² See option: SPLH-WV-CB-80x400

CLAD-MAN: ADVANTAGES

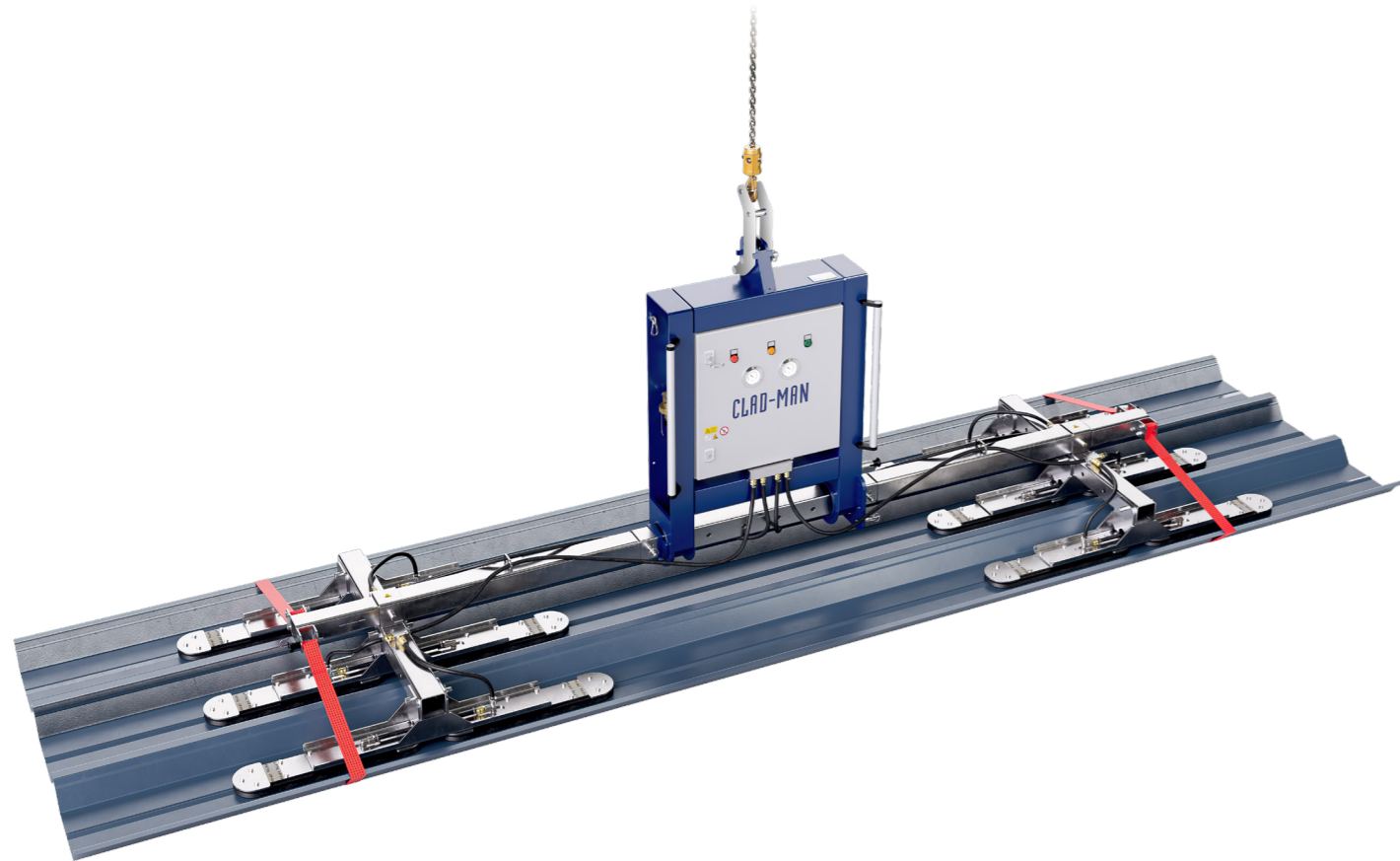

- **Big brother of the tried-and-tested CLAD-BOY with maximum load capacities of up to 800 kg.** In addition, elements with a length of up to 26 m can be manoeuvred with ease.
- **Versatile and robust:** Suitable for both roof and wall mounting
- **Maximum versatility and tool-free conversion** thanks to the modular and pluggable, hot-dip galvanised main cross beams
- **Specially designed for use on construction sites:** Absolutely weather-resistant, extremely impact-resistant and low unladen weight
- **Long running and short charging times** due to the battery-powered vacuum generator
- **Up to 70% longer battery life** thanks to the Ecomatic pump control module included as standard, which ensures intelligent activity control measured by the vacuum level.
- **Highest safety standards** because of an audible and visual warning signal when the battery is low and/or the vacuum level drops
- **Convenient transport and storage options** for all attachments and the vacuum lifter thanks to the specially designed STORE-MAN storage unit
- **70–80% longer service life than conventional products** thanks to the tried-and-tested, UV-resistant suction plates that can be replaced without tools
- **Threefold safety** due to the two-circuit system and double the load capacity of the overall system as well as the positive-locking belt securing. The two vacuum circuits work independently and protect each other against failure.
- **Ideal seal for the respective application:** Depending on the type and surface geometry of the transport good, users can freely choose between the sponge rubber or the extremely robust full elastomer seal.

CLAD-MAN

 < 800 kg
 up to 150 picks/battery charge
 Horizontal pick
 Vertical pick
 Swivelling

Material/lifting goods

 Sandwich elements
 Trapezoidal sheets



Further details about CLAD-MAN

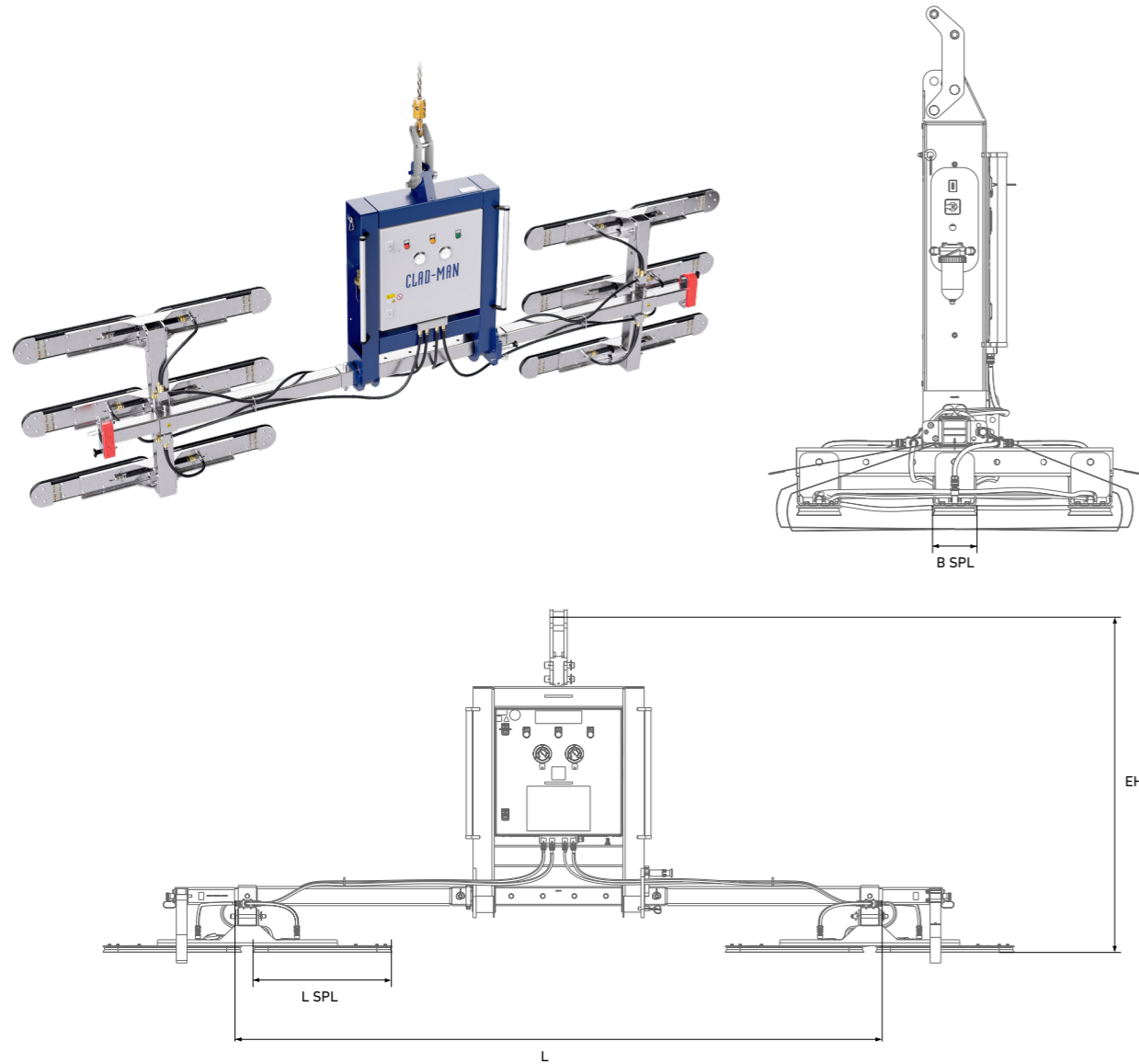

Dimension drawing



Optional configuration / Accessories

Designation	Item code	Description
 STORE-MAN	SM-CM-1440x750	The add-on for smart, safe and affordable transport
 Sponge rubber suction plate 140x700 mm	SPL-CM-140x700M	Compensates for higher structural unevenness (beading)
 Protective covers for 140x700 mm suction plate	SUEZ-CM-140x700	Recommended for protecting the 140x700 mm suction plate during transport

Product data

Load capacity		No. of suction pl.	Suction plate dimensions		Mounting height	Cross beam length	Max. transport goods length	Roof	Horizontal wall	Vertical wall	Item code
horizontal	vertical		B SPL	L SPL	EH	L					
[kg]	[kg]	[pieces]	Width [mm]	Length [mm]	Height [mm]	[mm]	[mm]				
800	600	12	140	650	1,280	3,000	13,000	✓	✓	-	CLAD-MAN-D-800/12L/3000
600	400	8	140	650	1,280	4,000	14,000	✓	✓	-	CLAD-MAN-D-600/8L/4000
400	-	8	140	650	1,280	16,000	26,000	✓	-	-	CLAD-MAN-D-400/8L/16000
800	800	16	140	650	1,280	3,000	12,000	✓	✓	✓	CLAD-MAN-W-800/16L/3000



CRANES AND CHAIN HOISTS



By combining vacuum lifting devices, cranes and chain hoists, we offer our customers a customised and complete handling system. Our services cover initial consultation and planning to the installation and commissioning of customised solutions.

With our many years of expertise, we are at your side throughout the entire process. We also offer the option of seamlessly integrating our solutions into existing infrastructures. We understand the complexity of production plants and are prepared to make adjustments to ensure that our technology fits perfectly into the existing environment.

OUR CRANE SYSTEMS:

- Column-mounted slewing jib cranes for mounting on hall floors (slewing range 270°)
- Wall-mounted slewing jib cranes for mounting on a wall or support (slewing range 180°)

Product series	Max. load capacity	Max. boom	Mounting	Suitable for tube lifters	Suitable for lifting devices for sheet metal/plastics, lifting devices for wood, lifting devices for glass
Aluminium column-mounted slewing jib crane	320 kg	6,000 mm	Chemical anchors, bonded anchors	✓	✓
Mobile aluminium column-mounted slewing jib crane	125 kg	6,000 mm	Base plate with forklift pockets	✓	✓
Aluminium wall-mounted slewing jib crane	320 kg	6,000 mm	Wall bracket	✓	✓
Steel column-mounted slewing jib crane	1,000 kg	6,000 mm	Bonded anchor	✓	✓
Steel wall-mounted slewing jib crane	1,000 kg	6,000 mm	Wall bracket	✓	✓

Alternative mounting types and other installation and Mounting heights are available on request.

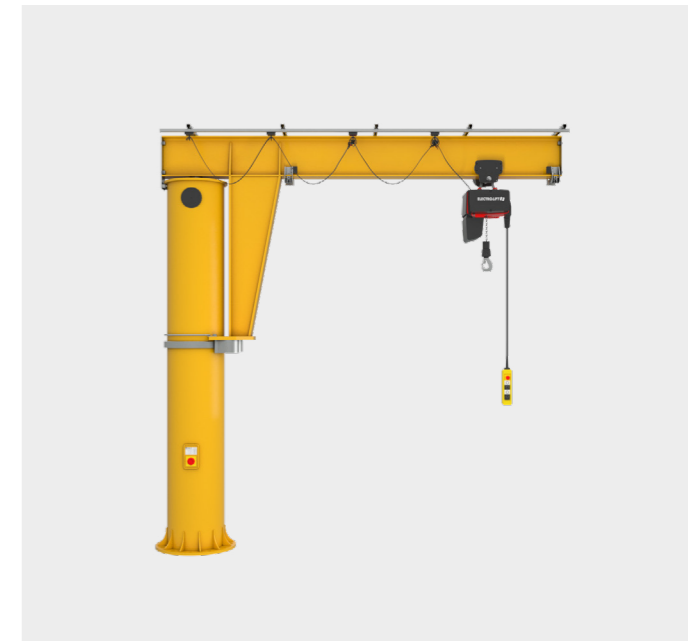

We also offer suitable chain hoists with different load capacities for our lifting devices.

PRODUCT OVERVIEW OF CHAIN HOISTS:

Load capacity	Main hoist speed	Fine hoist speed	Hook path	Control line length	Control cable length	Operating voltage
[kg]	[m/min]	[m/min]	[mm]	[mm]	[mm]	[V]
250	8	2	5,000	7,000	5,000	400
500	8	2	5,000	7,000	5,000	400
1,000	6	1.5	5,000	7,000	5,000	400

AERO-LIFT VAKUUMTECHNIK GMBH

Do you have further questions about our product portfolio or would you like to receive a specific quotation?

Regardless of the issue or industry, we have experts on our team for every problem who can show you the options for your specific challenge. We will be happy to work with you to analyse your entire value stream and determine the right handling solution for your company.

We can respond to inquiries from outside Germany thanks to our international partner network and we look forward to receiving your inquiry.



Please contact us:
sales@aero-lift.de or
+49 (0) 7428 94514 11

Do you need support for maintenance, service or repairs?

Regardless of whether you want to have your device serviced or simply need quick and pragmatic help, our expert service staff will assist you quickly at any time with their technical understanding.



Please contact us:
service@aero-lift.de or
+49 (0) 7428 94514 56





moving limits

AERO-LIFT Vakuumtechnik GmbH

Turmstraße 1

72351 Geislingen-Binsdorf

Germany

Phone: +49 (0) 7428 94514 0

info@aero-lift.de

www.aero-lift.de/en